

Drive Goods SSCNET Conversion Unit Model DG2GWY13 User's Manual (Hardware)

SAFETY PRECAUTIONS

(Please read the instructions carefully before using the equipment.)

Before using this product, please read this manual and the relevant manuals introduced in this manual carefully and pay full attention to safety to handle the product correctly. The precautions described in this manual are concerned with this product only. For Motion controller system safety precautions, refer to the user's manual of the CPU module used. In this manual, the safety instructions are ranked as "DANGER" and "CAUTION".

DANGER Indicates that incorrect handling may cause hazardous conditions, resulting in death or severe injury.

CAUTION Indicates that incorrect handling may cause hazardous conditions, resulting in medium or slight personal injury or physical damage.

Note that the **CAUTION** level may lead to a serious consequence according to conditions. Please follow the instructions of both levels because they are important to personnel safety. Please save this manual to make it accessible when required and always forward it to the end user.

Design Precautions

DANGER

- Configure safety circuits external to the conversion unit to ensure that the entire system operates safely even when a fault occurs in the external power supply or the conversion unit. Failure to do so may result in an accident due to a malfunction or incorrect output.
- Configure external safety circuits, such as an emergency stop circuit, protection circuit, and protective interlock circuit for forward/reverse operation or upper/lower limit positioning.
- When the conversion unit detects an error such as a watchdog timer error by the self-diagnostic function, all outputs are turned off. Also, output controls may not work when an error occurs in the part, such as I/O control part, where the conversion unit cannot detect any error. To ensure safety operation in such a case, provide a safety mechanism or external circuit.
- Outputs may remain on or off due to a failure of an output module relay, transistor, or triac. To ensure safety operation, configure an external circuit to monitor output signals that could cause a serious accident.

CAUTION

- Noise interference can cause erroneous data to be written to the conversion unit, resulting in an incorrect operation of the conversion unit which may cause an accident, or damage the machine. Always ensure the following items are observed.
 - Do not bundle main circuit lines or high-voltage lines with load lines. Do not keep these lines close to each other as they are easily affected by noise and surge induction. When wiring, keep the above lines at least 100 mm apart.
 - The shield of shielded cords and shielded cables must be grounded to a point on the programmable controller side. However, do not use a common ground with strong electrical equipment.
 - Input, power supply, and optical fiber connectors should be used without any force applied on them. Excessive force will cause cables to disconnect and fail.
- Provide appropriate circuits external to the conversion unit to prevent cases where danger may result from abnormal operation of the overall system in the event of an external power supply fault or conversion unit failure.
- If a fault occurs in the conversion unit or servo amplifier, shut off the power at the servo amplifier's power source. If a large current continues to flow, fire may occur.
- Do not apply a voltage other than that specified in the instruction manual on any terminal. Doing so may cause destruction or damage.
- Do not reverse the polarity (+ / -). Doing so can cause an explosion or damage.

Installation Precautions

CAUTION

- Never try to disassemble or modify the conversion unit. It may cause a product failure, operation failure, injury, or fire.
- Do not drop or apply strong impact on the conversion unit. Doing so will damage the unit.
- Use the conversion unit in an environment that meets the general specifications contained in this manual. Using the conversion unit in an environment outside the range of the general specifications could result in an electric shock, fire, operation failure, and damage to or deterioration of the unit.
- When using the conversion unit in places subject to vibration, tighten the unit with screws. Tighten the screws within the specified torque range. Undertightening may cause a drop, short circuit or operation failure. Overtightening may cause a drop, short circuit, or operation failure due to damage to the screws or conversion unit.
- Switch off all phases of the externally supplied power used in the system before installing or removing the conversion unit. Not doing so could result in an electric shock or damage to the unit.
- Do not directly touch the conductive parts and electronic components of the conversion unit. Doing so may cause the unit to malfunction or be damaged.
- Lock the control panel and prevent access to those who are not certified to handle or install electric equipment.
- Mount the conversion unit, servo amplifier, servo motor, and regenerative resistor on incombustible material. Mounting them directly or close to combustibles will lead to fire.

Wiring Precautions

DANGER

- Switch off all phases of the externally supplied power used in the system before installation or wiring. Not doing so could result in an electric shock or damage to the product.

CAUTION

- Be sure to ground the earth terminal FG and LG. (Ground resistance: 100 Ω or less) Not doing so could result in an electric shock or operation failure.
- Check the product's rated voltage and the terminal layout. Make sure to wire the conversion unit correctly. Connecting a power supply that differs from the rating or incorrectly wiring the product could result in fire or damage.
- External connections shall be crimped or pressure welded with the specified tools, or correctly soldered. Imperfect connections could result in a short circuit, fire, or operation failure.
- Tighten the terminal screws within the specified torque range. Undertightening may cause a drop, short circuit, fire, or operation failure. Overtightening may cause a drop, short circuit, or operation failure due to damage to the screws or conversion unit.
- Make sure that no foreign matter such as sawdust or wiring debris enters the conversion unit. Such debris could cause fire, damage, or operation failure.
- Do not reverse the polarity (+ / -). Doing so can cause an explosion or damage.

Startup and Maintenance Precautions

DANGER

- Do not touch the terminals while power is on. Otherwise, it may cause an electric shock.
- Switch off all phases of the externally supplied power used in the system before cleaning the conversion unit or retightening the terminal or unit mounting screws. Not doing so could result in an electric shock. Undertightening may cause a drop or operation failure. Overtightening may cause a drop, short circuit, or operation failure due to damage to the screws or conversion unit.

CAUTION

- Never try to disassemble or modify the conversion unit. It may cause a product failure, operation failure, injury, or fire.
- Use any radio communication device such as a cellular phone or a PHS phone more than 25 cm away from the conversion unit in all directions. Not doing so may cause a malfunction.
- Switch off all phases of the externally supplied power used in the system before installing or removing the conversion unit. Not doing so may cause the unit to fail or malfunction.
- Before touching the conversion unit, always touch grounded metal, etc. to discharge static electricity from human body. Not doing so may cause the unit to fail or malfunction.
- Do not directly touch the conductive parts and electronic components of the conversion unit. Doing so could cause the unit to malfunction or fail.

Disposal Precautions

DANGER

- A capacitor is mounted into the conversion unit. Do not incinerate the conversion unit, or the capacitor may burst. For disposal of the conversion unit, request for the specialized industrial waste disposal service who has incineration facilities.

Dispose of this product according to your local laws and regulations.

CAUTION

- This product is not designed or manufactured to be used in equipment or systems in situations that can affect or endanger human life.
- When considering this product for operation in special applications such as machinery or systems used in passenger transportation, atomic power, electric power, aerospace, or medical applications, please contact your nearest Mitsubishi sales representative.
- Although this product was manufactured under conditions of strict quality control, the product shall be systematically provided with backup and fail-safe functions when it is used in facilities where breakdowns of the product are likely to cause a serious accident or damage.

Transportation Precautions

CAUTION

- When not using the product for a long time, disconnect the power line from the unit or power amplifier.
- Place the conversion unit and servo amplifier in anti-static vinyl bags to store.

About the manuals

Order the following manuals that are related to this product if necessary.

POINT

Except for the conversion unit (DG2GWY13) and the 24 V DC power supply input connector (DG8PW3CN), the software package, modules, and cables of Mitsubishi Electric Corporation are used to configure the systems described in this manual.

Detailed manual

Manual name	Manual No.
DG2GWY13 SSCNET Conversion Unit User's Manual (Detailed)	50GR-041197

Relevant manuals of the products manufactured by Mitsubishi Electric Corporation

Manual name	Manual No.
MELSERVO-J4 Servo Amplifier Instruction Manual (Troubleshooting)	SH(NA)030109
MR-J4- B (-RJ) Servo Amplifier Instruction Manual	SH(NA)030106
MR-J4W2- B, MR-J4W3- B, MR-J4W2-0303B6 Servo Amplifier Instruction Manual	SH(NA)030105
MR-J3- B Servo Amplifier Instruction Manual	SH(NA)030051
MR-J3W-0303B6, MR-J3W- B Servo Amplifier Instruction Manual	SH(NA)030073

Generic terms and abbreviations

Unless otherwise specified, this manual uses the following generic terms and abbreviations.

Generic terms/abbreviations	Description
Conversion unit	DG2GWY13 SSCNET conversion unit
MELSOFT MT Works2	Motion controller engineering software package
MT Developer2	Programming software included in MELSOFT MT Works2
MR Configurator2	Servo setup software MR Configurator2 (version 1.00A or later)
A Motion controller	A171SHCPU(N)/A172SHCPU(N)/A173UHCPU/A273UHCPU(-S) Motion controller
Q Motion controller	Q172CPU(N)/Q173CPU(N) Motion controller
SSCNET	Communication network between the Motion controller and the conversion unit
SSCNET III/H	Communication network between the conversion unit and the SSCNET III/H compatible servo amplifier
SSCNET III	Communication network between the conversion unit and the SSCNET III compatible servo amplifier
SW3RNC-GSV	Integrated startup support software for the A series Motion controller
A270CDBL03M cable	Cable for the SSC I/F card
J3 compatibility mode	MR-J4-B series servo amplifier operation mode which is compatible with MR-J3-B series servo amplifier
SSCNET III/H compatible servo amplifier	MR-J4-B / MR-J4W2-B / MR-J4W3-B servo amplifier
SSCNET III compatible servo amplifier	MR-J4-B(J3 compatibility mode) / MR-J4W2-B(J3 compatibility mode) / MR-J4W3-B(J3 compatibility mode) / MR-J3-B / MR-J3W-B servo amplifier

Compliance to the EMC and Low Voltage Directives

Compliance to the EMC Directive, which is one of the EU Directives, has been a legal obligation for the products sold in European countries since 1996 as well as the Low Voltage Directive since 1997.

To prove the compliance with the EMC and Low Voltage Directives, manufacturers must issue an EC Declaration of Conformity and the products must bear a CE marking.

(1) Authorized representative in Europe

The authorized representative in Europe is shown below.
Name: Mitsubishi Electric Europe B.V.
Address: Gothaer strasse 8, 40880 Ratingen, Germany

(2) Installation to the control panel

The conversion unit is an open type device. Ensure the conversion unit is installed inside a control panel for use. Also, install the remote stations of each network inside the control panel.

Waterproof type remote stations can be installed outside of the control panel. Installing the conversion unit inside a control panel ensures both safety and effective shielding of electromagnetic noise generated by the conversion unit.

1) Control panel

- Use a conductive control panel.
- When attaching the control panel's top plate or base plate using bolts, mask the area used for grounding so that the area is not painted.
- To ensure good electrical contact with the control panel, mask the mounting bolt area of the inner plate in the control panel so that contact between surfaces can be ensured over the widest possible area.
- Ground the control panel with a thick wire to ensure a low impedance connection to ground even at high frequencies.
- Holes in the control panel must measure 10 cm or less in diameter, or radio frequency noise may be emitted. In addition, because radio waves leak through a clearance between the control panel door and the main unit, reduce the clearance as much as practicable.

2) Connection of power line and ground wire

- Provide a grounding point near the FG terminals. Ground the FG terminals with the thickest and shortest possible wire (wire length: 30 cm or shorter, diameter: 2 mm or less).
- Twist the grounding wire from the grounding point with the power supply wire. This enables more noise from the power supply wire to run off to the ground. However, when a noise filter has been installed on the power supply wire, twisting with the grounding wire is not required.

1. OVERVIEW

- Conversion unit (model: DG2GWY13) can be selected communication type SSCNET III/H or SSCNET III.
- By selecting communication type SSCNET III/H, the drive section of a system can be upgraded from SSCNET compatible servo amplifiers (MR-J2S-B/MR-J2M-B/MR-J2-B/MR-H-B/MR-J4-B-RJ020+MR-J4-T20) to SSCNET III/H compatible ones.
- By selecting communication type SSCNET III, the drive section of a system can be upgraded from SSCNET compatible servo amplifiers to SSCNET III compatible ones.
- Since the controller and drive sections can be upgraded independently, the potential risks at upgrading can be reduced and the machine halt time can be shortened.
- The range of upgrading is flexible since the drive section can be upgraded by SSCNET line (max. 16 axes).
- Existing design assets can be used.

2. SYSTEM CONFIGURATION

- Overall configuration of the system (product model, related product model)
The following shows the overall configuration of the system when the conversion unit is used.

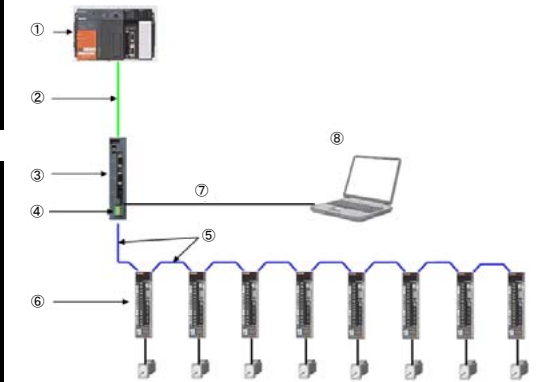

No	Item	Model	Description
①	A Motion controller	A171SHCPU(N) A172SHCPU(N) A173UHCPU A273UHCPU(-S)	SSCNET compatible controller
	Q Motion controller	Q172CPU(N) Q173CPU(N)	SSCNET compatible controller
②	SSCNET cable	MR-J2HBUS_M-A	A Motion controller ↔ conversion unit
		Q172J2BCBL_M	Q172CPU(N) ↔ conversion unit
		Q173J2B_CBL_M	Q173CPU(N) ↔ conversion unit
		Q173DVCBL_M	Q173CPU(N) ↔ dividing unit(Q173DV)
③	Conversion unit	MR-J2HBUS_M	Dividing unit(Q173DV) ↔ conversion unit
		SSCNET (max. 8 axes × 2 lines) → SSCNET III/H(SSCNET III)(max. 16 axes)	
④	24 V DC power supply input connector	DG8PW3CN	24 V DC power supply input connector
⑤	SSCNET III cable	MR-J3BUS_M MR-J3BUS_M-A MR-J3BUS_M-B	Conversion unit ↔ servo amplifier SSCNET III compatible servo amplifier
		MR-J4-B MR-J4W2-B MR-J4W3-B	SSCNET III/H compatible servo amplifier SSCNET III compatible servo amplifier
⑥	Servo amplifier	MR-J3-B MR-J3W-B	SSCNET III compatible servo amplifier
		MR-J4-B MR-J4W2-B MR-J4W3-B	SSCNET III/H compatible servo amplifier
⑦	USB cable	MR-J3USBCBL3M	Conversion unit ↔ personal computer
⑧	Parameter conversion tool software	MELSOFT MT Works2	For writing parameters to the conversion unit

3. Specifications

(1) General specifications

Item	Specifications					
Operating ambient temperature	0 to 55°C					
Storage ambient temperature	-25 to 75°C					
Operating ambient humidity	5 to 95%RH, no condensation					
Storage ambient humidity	5 to 95%RH, no condensation					
Vibration resistance	Compliant with JIS B 3502 and IEC 61131-2	Under intermittent vibration	Frequency	Constant acceleration	Half amplitude	Number of sweeps
		9 to 150 Hz	5 to 9 Hz	—	3.5mm	10 times in each of X, Y and Z directions (for 80 minutes)
			9 to 150 Hz	9.8m/s ²	—	—
		Under continuous vibration	5 to 9 Hz	—	1.75mm	—
9 to 150 Hz	4.9m/s ²	—	—	—		
Impact resistance	Compliant with JIS B 3502 and IEC 61131-2 (147 m/s ² , 3 times in each of X, Y and Z directions)					
Operating atmosphere	No corrosive gas					
Operating altitude	2000 m or less					
Installation location	Inside the control panel					
Overvoltage category (*1)	II or lower					
Pollution degree (*2)	2 or less					

- (1) Indicates the power distribution section to which the device is assumed to be connected, between the public power grid and the machinery within the premises. Category II applies to the devices that are supplied with power from fixed facilities. The surge withstand voltage is 500 V for devices with ratings up to 50 V.
- (2) Indicates the extent to which conductive substances are found in the device operating environment. Pollution degree 2 indicates an environment in which normally only nonconductive pollution occurs and the temporary conductivity caused by condensation is to be expected.

(2) SSCNET conversion function, performance specifications

Item	Performance and specifications of the conversion unit
Number of control axes	16 axes (16 axes per line)
Communication cycle	Input SSCNET 3.555 ms to 14.222 ms (A Motion controller/ Q Motion controller compatible)
	Output SSCNET III/H (SSCNET III) 3.555 ms (A Motion controller/ Q Motion controller compatible)
Power supply	20.4 to 26.4 V DC (ripple factor within 5%)
Consumption current	24 V DC (Class 2), 0.2 A
24 V DC power supply (recommended)	PS5R-SB24 (manufactured by IDEC CORPORATION)
Inrush current	20 A in 2 ms (24 V DC)
Communication function	USB: communication with a personal computer
Compliance to global standards	CE, UL/cUL, KC
Structure	Self-cooling, open (IP20)
Mounting	Mounting screw M5 × 10 mm or more, tightening torque range: 78 to 118 N·cm
	DIN rail Applicable DIN rail: TH35-7.5Fe, TH35-7.5Al (JIS C2812 compatible)
External dimensions (mm)	168 (H) × 30 (W) × 100 (D)
Weight (g)	260

POINT

- (1) Input power
- This conversion unit must be supplied with 24 V DC. An input voltage of 28 V DC or above can cause the unit to fail.
 - Perform voltage measurements at the input connector of the conversion unit, and select the DC power supply and wire with voltages ranging from 20.4 to 26.4 V DC (including the ripple voltage and spike voltage).
- (2) Power on
- Turn on or off the power at the primary side (AC side) of the DC power supply.
 - Permissible instantaneous power failure time
 - Select a DC power supply with a permissible instantaneous power failure time of 20 ms or more.

- (3) Names of each section
- The following shows the names of each section of the conversion unit.

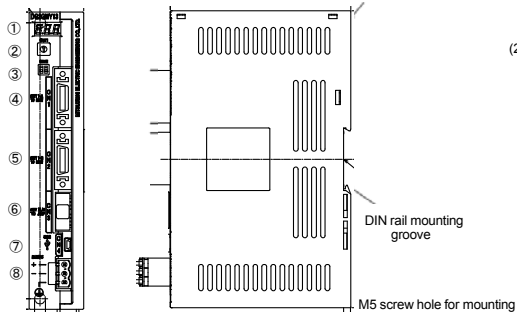

No	Name	Function	
①	7-segment LED display	Alarm display, status display	
②	Rotary switch (SW1)	"0": For parameter read/write "1", "3": For system operation "2", "4": For manufacturer setting	
③	Adjustment switch (SW2)	Switch for manufacturer setting (Always set this switch to OFF.)	
④	SSCNET connector (CN1)	Connector to connect the SSCNET CN1 line	
⑤	SSCNET connector (CN2)	Connector to connect the SSCNET CN2 line	
⑥	SSCNET III connector (CN3)	Connector to connect the SSCNET III CN3 line (CN3)	
⑦	USB communication connector (CN4)	USB port to connect a personal computer	
⑧	24 V DC power supply input connector (24VDC)	24 V DC power supply input connector	
		Notation	Signal name
		+	24V(+)
		-	24G
		FG	Grounding terminal

4. INSTALLATION AND WIRING

- (1) Mounting the conversion unit
- 1) Installation of one conversion unit

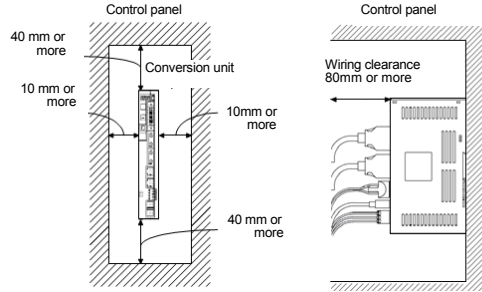

- 2) Installation of two conversion units
- Leave a large clearance between the inner surface of the control panel and the conversion units to circulate air above and below the conversion units. When mounting the conversion units, leave a clearance of 1 mm between the conversion units in consideration of mounting tolerances.

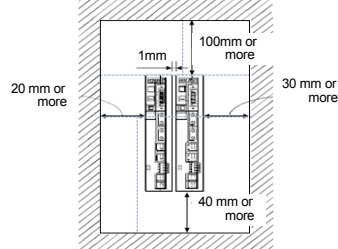

POINT

- When mounting the two conversion units closely, keep the ambient temperature within 0°C to 45°C.

- (2) Connecting the devices

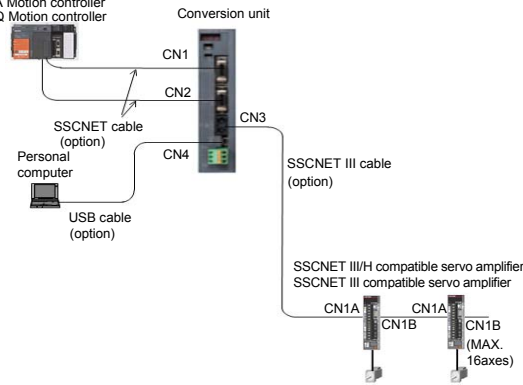

OSSCNET III cable

Cable	Cable model	Cable length
Standard cord inside panel	MR-J3BUS_M	0.15/0.3/0.5/1/3 m
Standard cable outside panel	MR-J3BUS_M-A	5/10/20 m
Long-distance cable	MR-J3BUS_M-B	30/40/50 m

OSSCNET cable

Cable	Cable model	Cable length
Bus cable	MR-J2HBUS_M-A	0.5/1/5m
	Q172J2BCBL_M	0.5/1/5m
	Q173J2B_CBL_M	0.5/1/5m
	Q173DVCBL_M	0.5/1m
	MR-J2HBUS_M	0.5/1/5m

OUSB cable

Cable	Cable model	Cable length
USB cable	MR-J3USBCBL3M	3m

- (3) Wiring the power supply connector

A spring connection plug connector is used for 24 V DC power supply input. No dedicated tools are required.

- 1) Applicable wire size and processing method

(a) Applicable wire size

The table below shows the wire size and type applicable to the 24 V DC power supply input connector.

Connector	Model	Applicable wire size and type
24 V DC power supply input connector	FKC-2.5/3-ST-5.08	0.3 to 2.5 mm ² (AWG12 to AWG22) Use copper wire only

- (b) Wire processing

The stripped length of the wire is as shown below.

Use the wire after stripping the sheath without twisting the core. At this time, take care to avoid a short caused by the loose wires of the core and the adjacent pole.

Do not solder the core, as it may cause a contact fault.

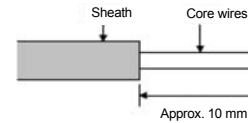

- * : When using a ferrule

A ferrule can also be used to connect with the connector.

Use the ferrules in the table below for the 24 V DC power supply connector.

Connector	Wire size	Ferrule model		Crimping tool	Manufacturer
		For 1 wire	For 2 wires		
24 V DC power supply input connector	AWG16	AI1.5-10 BK	AI-TWIN2 × 1.5-10 BK	CRIMPF OX-ZA3	Phoenix Contact
	AWG14	AI2.5-10 BU	—		

- Cut the wire sticking out from the end of the ferrule to 0.5 mm or less.



- When using a twin ferrule, be sure to insert the wire in a manner that will keep the insulation sleeve from interfering with the neighboring poles. Be sure to crimp the ferrule.

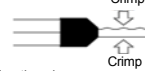

- 2) Inserting the wire

- (a) Press the connector release with a tool such as a flathead screwdriver.

- (b) While holding the release down, insert the wire all the way in.

- (c) Confirm the connection status.

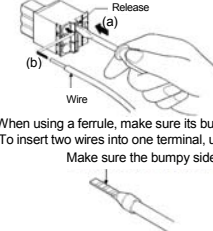

- When using a ferrule, make sure its bumpy side is facing toward the release. To insert two wires into one terminal, use a twin ferrule. Make sure the bumpy side is facing toward the release.

5. EXTERNAL DIMENSIONS

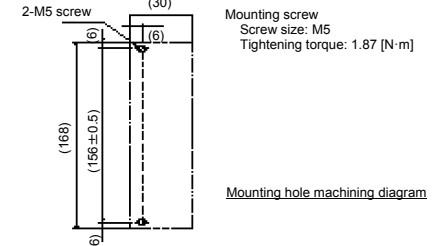
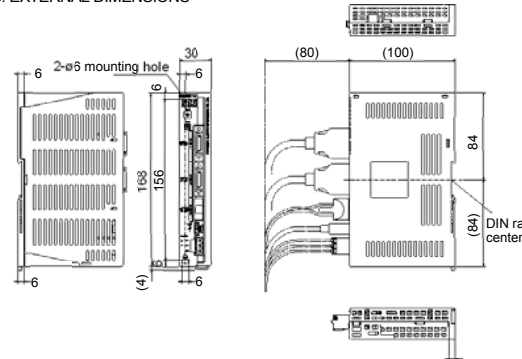

WARRANTY

Please confirm the following product warranty details before using this product.

Gratis Warranty Term and Gratis Warranty Range

We will repair any failure or defect hereinafter referred to as "failure" in our FA equipment hereinafter referred to as the "Product" arising during warranty period at no charge due to causes for which we are responsible through the distributor from which you purchased the Product or our service provider.

■ Gratis Warranty Term

The term of warranty for Product is twelve (12) months after your purchase or Warranty period for repaired Product cannot exceed the original warranty period before any repair work.

■ Gratis Warranty Range

This limited warranty applies only when the condition, method, environment, etc. of use are in compliance with the terms and conditions and instructions that are set forth in the instruction manual, user manual for the Product, and the caution label affixed to the Product.

Onerous Repair Term after Discontinuation of Production

- We may accept the repair at charge for another seven (7) years after the production of the Product is discontinued. The announcement of the discontinuation of production for each model is issued in our Sales and Service, etc.
- Please note that the Product (including its spare parts) cannot be ordered after its discontinuation of production.

Exclusion of Loss in Opportunity and Secondary Loss from Warranty Liability

Whether under or after the term of warranty, we are not liable for any damage arising from causes for which we are not responsible, any losses of opportunity and/or profit incurred by you due to a failure of the Product, any damage, secondary damage or compensation for accidents arising under a specific circumstance that are foreseen or unforeseen by our company, any damage to products other than the Product, and any other operations conducted by you.

Change of Product specifications

Specifications listed in our catalogs, manuals or technical documents may be changed without notice.

SSCNET, SSCNET II, SSCNET III/H and MELSOFT MT Works2 are registered trademarks or trademarks of Mitsubishi Electric Corporation.

사용자 안내문	
A급기기	이 기기는 업무용(A급) 전자파적합기기로서 판매자 또는 사용자는 이 점을 주의하시기 바랍니다. 가정외의 지역에서 사용하는 것을 목적으로 합니다.
(업무용 방출통신기자재)	

MITSUBISHI ELECTRIC ENGINEERING

1-13-5 Kudankita, Chiyoda-ku, Tokyo, Japan 102-0073
URL <http://www.mee.co.jp/>

This document is a new publication, effective August 2018.
Specifications are subject to change without notice.

Developed August 2018
50GR-041201-F