

**Mitsubishi General-Purpose Programmable Controller  
Renewal Tool Conversion Adapter**

Model

**ERNT-AQTY22**

**User's Manual**

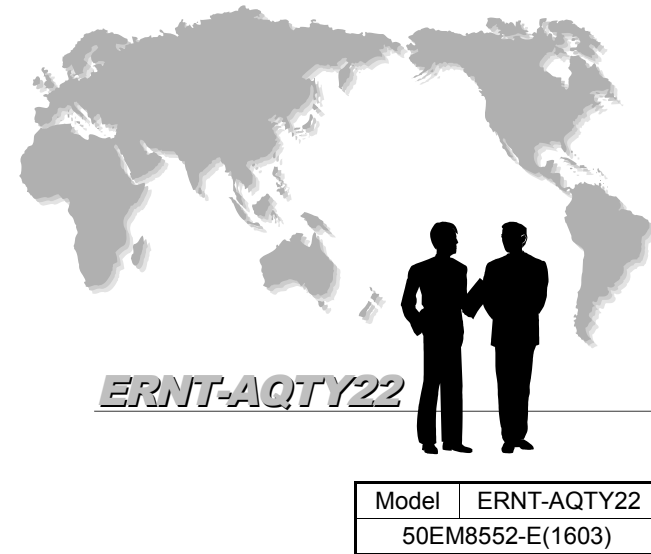

Model	ERNT-AQTY22
	50EM8552-E(1603)

**MITSUBISHI ELECTRIC ENGINEERING COMPANY LIMITED**

HEAD OFFICE: 1466 KUDAN BLDG.1-13/F, KUDANKITA CHYODAI-KU, TOKYO 102-8073, JAPAN  
NAGOYA ENGINEERING OFFICE: 139 SHIMOHASHIKOCHO-SHIMOHASHIKI, KASUGAI, AICHI 486-0906, JAPAN

● SAFETY PRECAUTIONS ●

(Always read these precautions prior to use.)

Before using this product, please read this manual carefully and pay full attention to safety to ensure that the product is used correctly.

The precautions presented in this manual are concerned with this product only. For Programmable Controller system safety precautions, refer to the user's manual of the MELSEC-Q series CPU module to be used.

In this manual, the safety precautions are ranked as "WARNING" and "CAUTION".



**WARNING** Indicates that incorrect handling may cause hazardous conditions, resulting in death or severe injury.

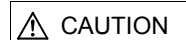

**CAUTION** Indicates that incorrect handling may cause hazardous conditions, resulting in medium or minor injury and/or property damage.

Note that failure to observe the CAUTION level instructions may lead to a serious consequence according to the circumstances. Always follow the precautions of both levels because they are important to personal safety.

Please keep this manual in an easy-to-access location for future reference, and be sure to provide the manual to the end user.

Installation Precautions



- Use the conversion adapter and conversion adapter anchor base in an environment of the general specifications defined in the MELSEC-Q series CPU module user's manual. Failure to do so could lead to electric shock, fire, malfunction or product failure or deterioration.
- Do not come in direct contact with the conductive area of the conversion adapter. Doing so could lead to system malfunction or failure.
- Fully secure the conversion adapter and conversion adapter anchor base using the installation screws, and tighten the installation screws securely within the specified torque range. Failure to do so could cause the conversion adapter and anchor base to fall, resulting in conversion adapter and conversion adapter anchor base damage.
- Always check for correct match between MELSEC-Q Series and the conversion adapter. Incorrect match can cause damage to the MELSEC-Q Series module.

Wiring Precautions



- Be sure to shut off all phases of the external power supply before performing installation or wiring work. Failure to do so could result in electric shock or product damage.
- If you want to energize and run the unit after completing the installation and wiring work, be sure to close the terminal block cover attached to the MELSEC-A series terminal block. Failure to do so could result in electric shock.



- Properly wire the conversion adapter after verifying the rated voltage and terminal layout of the input/output module to be used. Connecting a power supply with a different rating or improper wiring could lead to fire or product failure.
- Securely tighten the conversion adapter installation screws, conversion adapter anchor base installation screws and MELSEC-A series terminal block installation screws within the specified torque range. A loose screw may result in a short circuit, fire or malfunction. An excessively tightened screw may result in screw or conversion adapter damage, causing the conversion adapter to fall, a short circuit or product malfunction.
- Do not allow foreign matter such as cuttings or wiring shavings to enter the conversion adapter or module. Doing so could lead to fire, failure or malfunction.

Startup and Maintenance Precautions



- Do not touch the terminals during energization. Doing so could result in electric shock or malfunction.
- Be sure to shut off all phases of the external power supply before cleaning and retightening the terminal screws. Failure to do so could lead to electric shock. Excessively tightened screws could result in conversion adapter or input/output module damage, causing the conversion adapter to fall, a short circuit or product malfunction.

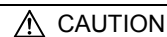

- Do not disassemble or modify the conversion adapter. Doing so could lead to failure, malfunction, injury or fire.
- The conversion adapter case is made of resin. Do not drop or apply excessive impact to the case. Doing so could lead to conversion adapter damage.

Disposal Precautions

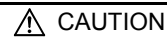

- When disposing of the product, treat it as industrial waste.

● 安全注意事项 ●

(使用前请务必阅读)

使用本产品时,请仔细阅读本手册,并充分注意安全,正确地使用产品。

本手册中标注的注意事项仅记载了与本产品相关的内容。关于可编程控制器系统的安全注意事项,请参阅所使用的MELSEC-Q系列CPU模块的用户手册。

在本●安全注意事项●中,安全注意事项的等级分为「警告」和「注意」。



**警告** 表示错误操作可能造成危险后果,引起死亡或重伤事故。

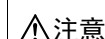

**注意** 表示错误操作可能造成危险后果,引起中度伤害、轻伤及财产损失。

另外,根据情况不同,即使是注意中记载的事项,也可能引发严重后果。不管哪个记载的都是非常重要的内容,请务必遵守。

请妥善保管本手册,以便需要时取阅,并将本手册交给最终用户。

【安装注意事项】

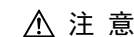

- 应在MELSEC-Q系列CPU模块用户手册中记载的一般规格环境下使用转换适配器及转换适配器固定台。如果在一般规格范围以外的环境中使用,可能导致触电、火灾、误动作、产品的损坏或劣化。
- 请不要直接接触转换适配器的导电部分。否则可能会导致系统误动作、故障。
- 转换适配器及转换适配器固定台应通过安装螺栓切实地加以固定,安装螺栓应在规定的扭矩范围内切实地拧紧。可能因掉落而导致转换适配器及转换适配器固定台破损。
- 请务必确认MELSEC-Q系列模块和转换适配器的组合是否正确。在错误组合下使用时,可能会导致MELSEC-Q系列模块损坏。

【接线注意事项】



- 必须将外部供应全相断开断开后再进行安装作业等。如果未全相断开,可能会导致触电或产品损坏。
- 安装、配线作业完成之后进行通电、运行时,必须关闭MELSEC-A系列端子排的端子排盖板。如果未关闭端子排盖板,可能会导致触电。

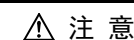

- 请确认所使用输入/输出模块的额定电压及端子排列后正确地进行转换适配器的配线。连接不符合额定值的电源或误配线,会导致火灾或故障。

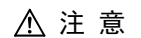

- 转换适配器安装螺栓、转换适配器固定台安装螺栓、MELSEC-A系列端子排安装螺栓应在规定的扭矩范围内切实地拧紧。如果螺栓拧得过松,会导致短路、火灾或误动作。如果螺栓拧得过紧,有可能造成螺栓及转换适配器破损从而导致掉落、短路或误动作。
- 请注意不要让切屑或接线头等异物进入转换适配器及模块内。会导致火灾、故障、误动作。

【启动和维护注意事项】



- 在通电状态下请勿触摸端子。可能会导致触电或误动作。
- 在清扫或重新紧固端子螺栓时,必须将外部供应全相断开断开后再进行。如果未全相断开,可能会导致触电。如果螺栓拧得过紧,可能会导致转换适配器或输入/输出模块的破损从而导致掉落、短路或误动作。

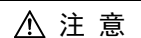

- 请不要拆卸、改造转换适配器。否则可能会导致故障、误动作、受伤或火灾。
- 转换适配器的外壳由树脂制成,因此请避免掉落或使其受到剧烈冲击。否则可能会损坏转换适配器。

【废弃注意事项】

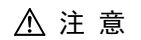

- 废弃时请将本产品作为工业废弃物处理。

Related Manuals

Manual Title	Manual No. (Model Code)	Remarks
MELSEC-Q Series Building Block I/O Module User's Manual	SH-080042 (13JL99)	By Mitsubishi Electric Corporation

EMC AND LOW VOLTAGE DIRECTIVES

Compliance to the EMC Directive, which is one of the EU Directives, has been a legal obligation for the products sold in European countries since 1996 as well as the Low Voltage Directive since 1997.

Manufacturers who recognize their products are compliant to the EMC and Low Voltage Directives are required to declare that print a "CE mark" on their products.

Authorized representative in Europe

Authorized representative in Europe is shown below.

Name: Mitsubishi Electric Europe BV

Address: Mitsubishi-Electric-Platz 1, 40882 Ratingen, Germany

1. Overview

This manual describes the Mitsubishi general-purpose Programmable Controller renewal tool conversion adapter (ERNT-AQTY22). The conversion adapter is a product that converts the differences in MELSEC-A series and MELSEC-Q series pin assignments.

Once you have opened the packaging, verify that it contains the following products.

Product	Quantity
Conversion adapter	1
Mounting bracket	1
Mounting bracket fixing screw (M3.5 x 6)	2

## 2. Conversion Adapter Product Specifications

Conversion Adapter Model	A Series Module Model	No. of Connection Points	Q Series Module Model	Conversion Adapter Weight (g)
ERNT-AQTY22	AY22	16 points	QY22	130

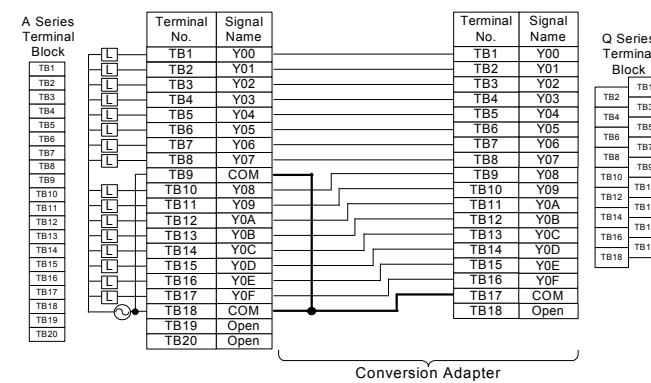

## 3. Products Required by the Conversion Adapter

### (1) Conversion Adapter Anchor Base (Sold Separately)

The conversion adapter anchor base secures the bottom of the conversion adapter and is required for conversion adapter use. One anchor base is required per base.

Conversion Adapter Anchor Base Model	Specifications	
	Type	Weight (g)
ERNT-AQF12	12-slot conversion adapter anchor base	590
ERNT-AQF8	8-slot conversion adapter anchor base	410
ERNT-AQF5	5-slot conversion adapter anchor base	275
ERNT-AQF3	3-slot conversion adapter anchor base	185

### (2) Base Adapter (Sold Separately)

The base adapter enables MELSEC-Q series installation using the installation holes of the MELSEC-A series base unit. (Additional hole machining not required)

Base Adapter Model	Specifications			Weight (g)
	MELSEC-A Series Compliant Module	MELSEC-Q Series Compliant Module	Installable Conversion Adapter Anchor Base	
ERNT-AQB38	A38B	Q312B	ERNT-AQF12	970
	A38B-UL	Q38B	ERNT-AQF8	
	A38B-E			
	A38HB A38HBEU			
ERNT-AQB68	A68B	Q612B		930
	A68B-UL	Q68B		
ERNT-AQB58	A58B	Q68B	ERNT-AQF8	870
	A58B-UL			
ERNT-AQB35	A35B	Q38B	ERNT-AQF8	795
	A35B-UL	Q35B	ERNT-AQF5	
ERNT-AQB65	A65B	Q68B		790
	A65B-UL	Q65B		
ERNT-AQB55	A55B	Q65B	ERNT-AQF5	655
	A55B-UL	Q55B		
ERNT-AQB32	A32B	Q33B	ERNT-AQF3	675
	A32B-UL			
	A32B-E			
ERNT-AQB62	A62B	Q63B		650
		Q52B		
ERNT-AQB52	A52B	Q52B		505

## 5. Part Names and Installation Method

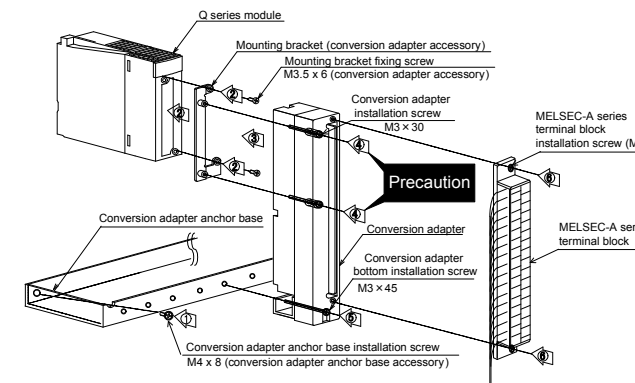

### 5.1 Installation Method

- Secure the conversion adapter anchor base to the base adapter or control panel using the conversion adapter anchor base installation screws (M4 × 8) provided as an accessory. (Two end locations)
- Secure the mounting bracket to the Q series module using the mounting bracket fixing screws [M3.5 × 6 (conversion adapter accessory); two upper/lower locations].
- Mount the conversion adapter onto the mounting bracket.
- Secure the conversion adapter using the conversion adapter installation screws (M3 × 30; 2 locations).

#### Precaution

Before tightening the installation screws, check that the Conversion Adapter has been securely installed on the MELSEC-Q Series module. Tightening the screws in floating-off state or tilting state will damage the Conversion Adapter installation screws and the mounting bracket.

- Secure the conversion adapter using the conversion adapter bottom installation screw (M3 × 45; 1 location).
- Secure the MELSEC-A series terminal block to the conversion adapter using the terminal block installation screws (M4; two upper/lower locations).

## 6. External Dimensions

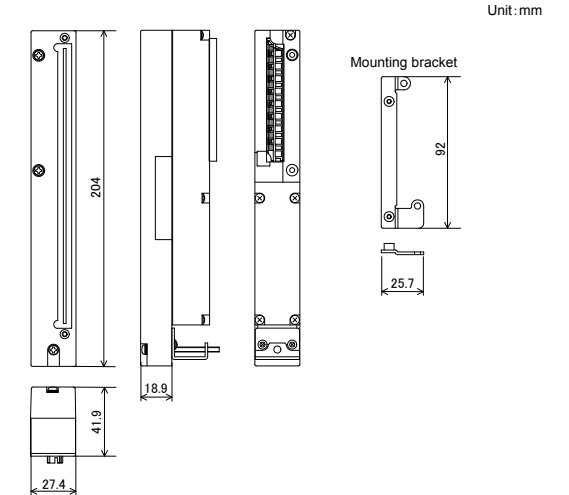

#### Duplication Prohibited

This manual may not be reproduced in any form, in part or in whole, without written permission from Mitsubishi Electric Engineering Company Limited.  
©2014 MITSUBISHI ELECTRIC ENGINEERING COMPANY LIMITED ALL RIGHTS RESERVED

MELSEC is a registered trademark of Mitsubishi Electric Corporation.

### Output Module Specification Comparison Chart

Specifications	Model	MELSEC-A Series	MELSEC-Q Series
		AY22	QY22
No. of input points		16 points	16 points
Isolation method		Photocoupler isolation	Photocoupler isolation
Rated load voltage		100 to 240V AC 50 / 60Hz±5%	100 to 240V AC (50/60Hz ±5%)
Maximum load voltage		2A/point, 3.3A/common	0.6A/point, 4.8A/common
Maximum load voltage/current		24V AC 100mA, 100V AC 10mA, 240V AC 20mA	24V AC 100mA, 100V AC 25mA, 240V AC 25mA
Maximum inrush current		40A 10ms or less, 15A 100ms or less	20A 1 cycle or less
OFF leakage current		1.5mA (120V AC 60Hz), 3mA (240V AC 60Hz)	1.5mA or less (at 120V, 60Hz), 3mA or less (at 240V, 60Hz)
Maximum voltage drop at ON		1.5V AC or less (1 to 2A), 1.8V AC or less (0.2 to 1A), 5V AC or less (0.2A or less)	1.5V or less
Response time	OFF → ON	1ms or less	1ms+0.5CYCLE or less
	ON → OFF	0.5 CYCLE+1ms or less	1ms+0.5CYCLE (rated load, resistance load)
Surge killer		CR absorber (0.022μF+47Ω) Varistor (387 to 473V)	CR absorber
Fuse		Available	None (Fuse installation recommended at external wiring)
Internal current consumption		305mA (TYP. All points ON)	250mA (MAX. All points ON)
Wiring method for common		8 points, 1 common	16 points, 1 common
External connection system		20-point terminal block	18-point terminal block

#### Note:

- A wiring change is required if the MELSEC-A series terminal numbers TB9, 18 have been separated due to a change in the number of points per common from 8 points (2 circuits) to 16 points.
- For detailed specifications not stated in the Output Module Specification Comparison Chart and for general specifications, refer to the user's manual of the output module to be used. Those areas with specifications that are different for the MELSEC-A series and MELSEC-Q series are subject to specification restrictions upon replacement. Check the specifications of the connection device.

## 4. Mounting and Installation

### 4.1 Handling Precautions

- Do not touch the terminals during energization. Doing so could result in electric shock or malfunction.
- Do not disassemble or modify the conversion adapter. Doing so could result in failure, malfunction, injury or fire.
- Do not come in direct contact with the conductive area of the conversion adapter. Doing so could result in system malfunction or failure.
- Fully secure the conversion adapter and conversion adapter anchor base using the installation screws, and securely tighten the screws within the specified torque range. Failure to do so could cause the conversion adapter and anchor base to fall, resulting in conversion adapter and conversion adapter anchor base damage.

### 4.2 Use Precautions

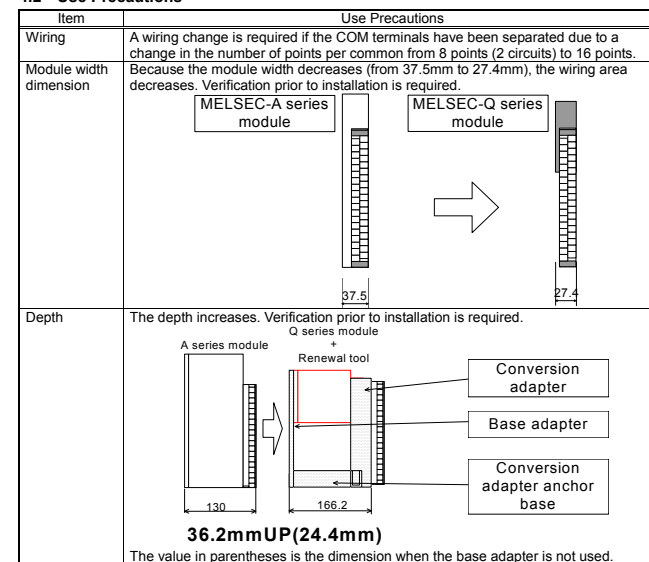

### 4.3 Installation Environment

For details of the installation environment, refer to the user's manual of the MELSEC-Q series CPU module to be used.

### 5.2 Tightening Torque

Tighten the module installation screws to the specified torque below. An inappropriate tightening torque could cause the product to fall or result in a short circuit, product failure or malfunction.

Screw Location	Tightening Torque Range
Conversion adapter anchor base installation screw (M4 screw)	139 to 189 N·cm
Mounting bracket fixing screw (M3.5 screw)	68 to 92 N·cm
Conversion adapter bottom installation screw (M3 screw)	43 to 57 N·cm
Conversion adapter installation screw (M3 screw)	
MELSEC-A series terminal block installation screw (M4 screw)	102 to 138 N·cm

### Product Warranty Details

Please confirm the following product warranty details prior to product use.

#### Gratis Warranty Terms and Gratis Warranty Range

If any fault or defect (hereinafter referred to as "Failure") attributable to Mitsubishi Electric Engineering Company Limited (hereinafter referred to as "MEE") should occur within the gratis warranty period, MEE shall repair the product free of charge via the distributor from whom you made your purchase.

#### ■ Gratis Warranty Period

The gratis warranty period of this product shall be one (1) year from the date of purchase or delivery to the designated place. Note that after manufacture and shipment from MEE, the maximum distribution period shall be six (6) months, and the gratis warranty period after manufacturing shall be limited to eighteen (18) months. In addition, the gratis warranty period for repaired products shall not exceed the gratis warranty period established prior to repair.

#### ■ Gratis Warranty Range

The gratis warranty range shall be limited to normal use based on the usage conditions, methods and environment, etc., defined by the terms and precautions, etc., given in the instruction manual, user's manual and caution labels on the product.

#### Warranty Period after Discontinuation of Production

- MEE shall offer product repair services (fee applied) for seven (7) years after production of the product has been discontinued. Discontinuation of production shall be reported via distributors.
- Product supply (including spare parts) is not possible after production has been discontinued.

#### Exclusion of Opportunity Loss and Secondary Loss from Warranty Liability

Regardless of the gratis warranty period, MEE shall not be liable for compensation for damages arising from causes not attributable to MEE, opportunity losses or lost profits incurred by the user due to Failures of MEE products, damages or secondary damages arising from special circumstances, whether foreseen or unforeseen by MEE, compensation for accidents, compensation for damages to products other than MEE products, or compensation for other work carried out by the user.

#### Changes in Product Specifications

The specifications given in the catalogs, manuals and technical documents are subject to change without notice.

This document is a new publication, effective March 2016. Specifications are subject to change without notice.