

DC I/O Conversion Module

FA-TB32XY,FA-TB32XYL/H,FA-TB32XYP3/N3,
FA-TBS32XY,FA-TBS40P,FA-TB1L32XY,
FA-LEB32XY/-3/-3A

User's Manual

Thank you for purchasing the FA Goods products.

Before using the products, please read this manual and the relevant manuals carefully to handle the products correctly.

mitsubishi electric engineering company limited

SAFETY PRECAUTIONS

(Read these precautions before using the FA Goods products.)

Before using the products, please read this manual and the relevant manuals carefully, and pay full attention to safety to handle the products correctly.

The precautions given in this manual are concerned with the FA Goods products only.

For the safety precautions of the programmable controller system, refer to the user's manual for the programmable controller used.

In this manual, the safety precautions are classified into two levels: "⚠️WARNING" and "⚠️CAUTION".

 **WARNING**

Indicates that incorrect handling may cause hazardous conditions, resulting in death or severe injury.

 **CAUTION**

Indicates that incorrect handling may cause hazardous conditions, resulting in minor or moderate injury or property damage.

Under some circumstances, failure to observe the precautions given under "⚠️CAUTION" may lead to serious consequences.

Observe the precautions of both levels because they are important for personal and system safety.

[Design Precautions]



WARNING

- Configure safety circuits externally to ensure that the entire system operates safely even when a fault occurs in the external power supply, the programmable controller, or the FA Goods products. Failure to do so may result in an accident due to an incorrect output or malfunction.
 - (1) Emergency stop circuits, protection circuits, and protective interlock circuits for conflicting operations (such as forward/reverse rotations or upper/lower limit positioning) must be configured externally.
 - (2) Outputs may remain on or off due to a failure of a component such as a relay, transistor, and triac in an output terminal module. Configure an external circuit for monitoring output signals that could cause a serious accident.
- In an output circuit of an output terminal module, when a load current exceeding the rated current or an overcurrent caused by a load short-circuit flows for a long time, it may cause smoke and fire. To prevent this, configure an external safety circuit, such as a fuse.
- Configure a circuit so that the programmable controller is turned on first and then the external power supply. If the external power supply is turned on first, an accident may occur due to an incorrect output or malfunction.

[Design Precautions]



CAUTION

- Do not install the control lines or communication cables together with the main circuit lines or power cables. Keep a distance of 100mm (3.94 inches) or more between them. Failure to do so may result in malfunction or failure due to noise.
- When using a terminal block conversion module for a high-speed counter module, do not install the control lines or communication cables together with the main circuit lines or power cables. Keep a distance of 150mm (5.91 inches) or more between them. Failure to do so may result in malfunction or failure due to noise.
- Keep a distance of 100mm (3.94 inches) or more between a thermocouple or RTD (Resistance Temperature Detector) and the main circuit line or AC control lines. Also, keep the thermocouple or RTD away from a circuit that includes harmonics, such as a high-voltage circuit and a load circuit of an inverter. If not, the thermocouple or RTD is more likely to be affected by noise, surges, and induction.
- At power-on or power-off, a voltage may occur or a current may flow between output terminals for a moment. To use an analog signal converter or analog terminal block conversion module, start the control after analog outputs become stable.
- Do not place an analog signal converter or analog terminal block conversion module near a device that generates magnetic noise.
- When a device such as a lamp, heater, or solenoid valve is controlled through an output terminal module, a large current (approximately 10 times greater than normal) may flow when the output is turned from off to on. Therefore, use an output terminal module that has a sufficient current rating.

[Installation Precautions]



WARNING

- Shut off the external power supply (all phases) used in the system before installation. Failure to do so may result in electric shock or damage to the products.

[Installation Precautions]



CAUTION

- Use FA Goods products in an environment that meets the general specifications in this manual. Failure to do so may result in electric shock, fire, malfunction, or damage to or deterioration of the products.
- Securely fix the products with a DIN rail or screws. Incorrect installation may cause malfunction, failure, or drop of the module. When using the products in an environment of frequent vibrations, fix the products with screws.
- Tighten the screws within the specified torque range. Undertightening can cause drop of the screw, short circuit, or malfunction. Overtightening can damage the screw and/or products, resulting in drop, short circuit, or malfunction.
- Attach DIN rail stoppers on the right and left sides of the spring clamp conversion module (FA1-TESV**) to fix the module securely.
- Shut off the external power supply (all phases) used in the system before mounting or removing the products. Failure to do so may result in damage to, malfunction of, or failure of the products.
- Do not directly touch any conductive parts and electronic components of the products. Failure to do so may cause malfunction or failure of the products.
- Install the products in the correct orientation if it is specified. Failure to do so may result in damage to or deterioration of the products.
- When drilling screw holes, be careful not to drop chips into the inside of the products or conductive parts. Such foreign matter can cause a fire, failure, or malfunction.
- When using replacement relays/triacs/transistors for a terminal module or signal conversion modules, use them in the correct combination. Incorrect combination may cause failure.
- Shut off the power supply before installing/removing a replacement relay/triac/transistor for a terminal module. Failure to do so may cause failure or malfunction.
- Securely install replacement relays/triacs/transistors on a terminal module and securely mount a signal conversion modules on an installation base. Failure to do so may cause damage to or drop of the products, or malfunction due to poor contact. Follow the correct procedure to install/remove them. Failure to do so may cause damage to or drop of the products, or malfunction due to poor contact.
- When relay/triac/transistor modules are installed on a terminal module or a signal conversion module is mounted on the installation base, hold the terminal module or installation base to transport them or install them to a panel. Holding the relay/triac/transistor or signal conversion module may cause drop or failure of the terminal module or installation base.

[Wiring Precautions]



WARNING

- Shut off the external power supply (all phases) used in the system before wiring. Failure to do so may result in electric shock or damage to the products.
- After wiring, attach the included terminal cover to the products before turning them on for operation. Failure to do so may result in electric shock.

[Wiring Precautions]



CAUTION

- Use applicable solderless terminals and tighten them within the specified torque range. Failure to do so may cause failure, damage, or malfunction.
- Check the rated voltage and terminal layout before wiring to the products, and connect the cables correctly. Connecting a power supply with a different voltage rating or incorrect wiring may cause a fire or failure.
- Do not install the control lines or communication cables together with the main circuit lines or power cables. Keep a distance of 100mm or more between them. Failure to do so may result in malfunction due to noise.
- When using a terminal block conversion module for a high-speed counter module, do not install the control lines or communication cables together with the main circuit lines or power cables. Keep a distance of 150mm (5.91 inches) or more between them. Failure to do so may result in malfunction or failure due to noise.
- Keep a distance of 100mm (3.94 inches) or more between a thermocouple or RTD (Resistance Temperature Detector) and the main circuit line or AC control lines. Also, keep the thermocouple or RTD away from a circuit that includes harmonics, such as a high-voltage circuit and a load circuit of an inverter. If not, the thermocouple or RTD is more likely to be affected by noise, surges, and induction.
- Do not place an analog signal converter or analog terminal block conversion module near a device that generates magnetic noise.
- Place the cables in a duct or clamp them. If not, dangling cable may swing or inadvertently be pulled, resulting in damage to the products or cables or malfunction due to poor contact.
- Tighten the terminal screws within the specified torque range. Undertightening can cause short circuit, fire, or malfunction. Overtightening can damage the screw and/or products, resulting in drop, short circuit, or malfunction.
- Tighten the connector screws within the specified torque range. Undertightening can cause short circuit, fire, or malfunction. Overtightening can damage the screw and/or products, resulting in drop, short circuit, fire, or malfunction.
- Securely connect connectors to the products. Failure to do so may cause malfunction.
- When disconnecting a cable from the products, do not pull the cable by the cable part. For the cable with connector, hold the connector part of the cable. For the cable connected to the terminal block, loosen the terminal screw. Pulling the cable connected to the products may result in malfunction or damage to the products or cable.
- Check the interface type and correctly connect the cable. Incorrect wiring (connecting the cable to an incorrect interface) may cause failure of the products and external device.
- Prevent foreign matter such as dust or wire chips from entering the products. Such foreign matter can cause a fire, failure, or malfunction.
- The products must be installed in control panels. Connect the main power supply to the products in the control panel through a relay terminal block. Wiring and replacement of the products must be performed by qualified maintenance personnel with knowledge of protection against electric shock.
- When connecting the products with a programmable controller, check that the product configuration is correct. An incorrect configuration may cause failure or malfunction.
- Use the products with no force applied to their connectors. Applied force may cause failure or disconnection.
- Attach protective covers or signal conversion modules to unused connectors or empty slots of the products. Failure to do so may cause a fire, failure, or malfunction due to foreign matter.
- When using replacement relays/triacs/transistors for a terminal module or signal conversion modules, use them in the correct combination. Incorrect combination may cause failure of a programmable controller, terminal module, installation base, or external device.
- Securely install replacement relays/triacs/transistors on a terminal module and securely mount a signal conversion modules on an installation base. Failure to do so may cause damage to or drop of the products, or malfunction due to poor contact. Follow the correct procedure to install/remove them. Failure to do so may cause damage to or drop of the products, or malfunction due to poor contact.
- Individually ground the FG terminal of the products with a ground resistance of 100 ohms or less. Failure to do so may result in electric shock or malfunction.

[Startup and Maintenance Precautions]

 **WARNING**

- Do not touch any terminal while power is on. Doing so will cause electric shock or malfunction.
- Shut off the external power supply (all phases) used in the system before cleaning the products or retightening the terminal screws, connector screws, or products fixing screws. Failure to do so may result in electric shock or cause failure or malfunction of the products. Undertightening can cause drop of the screw, short circuit, or malfunction. Overtightening can damage the screw and/or products, resulting in drop, short circuit, or malfunction.

[Startup and Maintenance Precautions]

 **CAUTION**

- Do not disassemble or modify the products. Doing so may cause failure, malfunction, injury, or a fire.
- Use any radio communication device such as a cellular phone or PHS (Personal Handy-phone System) more than 25cm away in all directions from the programmable controller and FA Goods products. Failure to do so may cause malfunction.
- Shut off the external power supply (all phases) used in the system before mounting or removing the products. Failure to do so may cause failure or malfunction of or damage to the products.
- After the first use of the products, do not connect/remove the products and cables more than 50 times (IEC 61131-2 compliant). Exceeding the limit may cause malfunction.
- Startup and maintenance of a control panel must be performed by qualified maintenance personnel with knowledge of protection against electric shock. Lock the control panel so that only qualified maintenance personnel can operate it.
- Before handling the products, touch a conducting object such as a grounded metal to discharge the static electricity from the human body. Failure to do so may cause failure or malfunction of the products.

[Disposal Precautions]

 **CAUTION**

- When disposing of the products, treat them as industrial waste.

[Transportation Precautions]

 **CAUTION**

- Do not apply shock that exceeds the shock resistance described in the general specifications during transportation since the products are precision devices. Doing so may cause failure of the module.
- The halogens (such as fluorine, chlorine, bromine, and iodine), which are contained in a fumigant used for disinfection and pest control of wood packaging materials, may cause failure of the products. Prevent the entry of fumigant residues into the product or consider other methods (such as heat treatment) instead of fumigation. The disinfection and pest control measures must be applied to unprocessed raw wood.

REVISIONS

*The manual number is given on the bottom left of the last page.

Print Date	*Manual Number	Revision
March, 2018	50D-FG0229	First edition

This manual confers no industrial property rights or any rights of any other kind, nor does it confer any patent licenses. Mitsubishi Electric Engineering cannot be held responsible for any problems involving industrial property rights which may occur as a result of using the contents noted in this manual.

© 2018 MITSUBISHI ELECTRIC ENGINEERING COMPANY LIMITED

CONTENTS

SAFETY PRECAUTIONS	1
1. INTRODUCTION	8
2. GENERAL SPECIFICATIONS	8
3. PERFORMANCE SPECIFICATIONS	9
3-1. FA-TB32XY	9
3-2. FA-TB32XYL, FA-TB32XYH	9
3-3. FA-TB32XYP3, FA-TB32XYN3	10
3-4. FA-TBS32XY	10
3-5. FA-TBS40P	11
3-6. FA-TB1L32XY	11
3-7. FA-LEB32XY, FA-LEB32XY-3, FA-LEB32XY-3A	12
4. CONNECTABLE MODULES AND CABLES	13
4-1. FA-TB32XY, FA-TBS32XY, FA-TB1L32XY, FA-LEB32XY, FA-LEB32XY-3, FA-LEB32XY-3A	13
4-2. FA-TB32XYL, FA-TB32XYH	14
4-3. FA-TB32XYP3, FA-TB32XYN3	15
4-4. FA-TBS40P	16
5. EXTERNAL DIMENSIONS	17
5-1. FA-TB32XY	17
5-2. FA-TB32XYL/H	17
5-3. FA-TB32XYP3, FA-TB32XYN3	17
5-4. FA-TBS32XY	18
5-5. FA-TBS40P	18
5-6. FA-TB1L32XY	18
5-7. FA-LEB32XY, FA-LEB32XY-3, FA-LEB32XY-3A	19
6. CONNECTING METHOD	20
6-1. Connection example with a connector module of a programmable controller	20
6-2. When connecting a 40P connector module of a non-Mitsubishi programmable controller (FA-TBS40P)	21
7. EXTERNAL CONNECTION EXAMPLE	22
7-1. FA-TB32XY, FA-TBS32XY	22
7-2. FA-TB32XYL	23
7-3. FA-TB32XYH	23
7-4. FA-TB32XYP3	24
7-5. FA-TB32XYN3	24
7-6. FA-TBS40P	25
7-7. FA-TB1L32XY	26
7-8. FA-LEB32XY	27
7-9. FA-LEB32XY-3	28
7-10. FA-LEB32XY-3A	29
8. APPLICABLE SOLDERLESS TERMINALS	30
8-1. FA-TB32XY, FA-TB32XYL/H, FA-TB32XYP3/N3, FA-LEB32XY, FA-LEB32XY-3/3A	30
8-2. FA-TBS32XY, FA-TBS40P	31
8-3. FA-TB1L32XY	32
9. PRECAUTIONS	33
10. GRATIS WARRANTY TERMS AND GRATIS WARRANTY RANGE	33
11. EXCLUSION FROM LIABILITY FOR OPPORTUNITY LOSS AND SECONDARY LOSS	33
12. TRADEMARKS	33

1. INTRODUCTION

This manual describes the specifications and handling of the terminal block conversion module used in combination with Mitsubishi Electric DC I/O modules.

2. GENERAL SPECIFICATIONS

Item	Specifications				
Operating ambient temperature	0 to 55°C				
Storage ambient temperature	-25 to 75°C				
Operating ambient humidity	5 to 95%RH, non-condensing				
Storage ambient humidity	5 to 95%RH, non-condensing				
Vibration resistance	Applicable standard	JIS B 3502, IEC 61131-2			
		Frequency	Constant acceleration	Half amplitude	Sweep count
	Under intermittent vibration	5 to 8.4Hz	—	3.5mm	10 times each in X, Y, and Z directions
		8.4 to 150Hz	9.8m/s ² (1G)	—	
	Under continuous vibration	5 to 8.4Hz	—	1.75mm	—
8.4 to 150Hz		4.9m/s ² (0.5G)	—		
Shock resistance	Compliant with JIS B 3502 and IEC 61131-2 (147m/s ² (15G), 3 times each in X, Y, and Z bidirections)				
Operating atmosphere	No corrosive gases				
Operating altitude ^{*1}	2000m or lower				
Installation location	Inside a control panel				
Overtoltage category ^{*2}	II or less				
Pollution degree ^{*3}	2 or less				

*1: Do not use or store the products under pressure higher than the atmospheric pressure of altitude 0m. Doing so may cause malfunction.

*2: This category indicates the section of the power supply to which the equipment is assumed to be connected between the public electrical power distribution network and the machinery within premises.

*3: This index indicates the degree to which conductive material is generated in terms of the environment in which the equipment is used.

3. PERFORMANCE SPECIFICATIONS

3-1. FA-TB32XY

Item		Model	FA-TB32XY
Number of I/O points, I/O device numbers			32 points, X0 to X1F or Y0 to Y1F
Rated voltage			24VDC (CLASS 2)
Maximum operating voltage			28.8VDC (CLASS 2)
Maximum operating current*1			Signal: 1A, Common: 2A
Terminal block	Terminal block screw		M3 screw, number of terminals: 34P, 7.62mm pitch, spring-up screw with finger protection cover
			Tightening torque range: 58.8 to 88.2N·cm (6 to 9kgf·cm, 5.22 to 7.5lbf·in), UL standard conformity tightening torque: 59N·cm, 5.22 lbf·in
	Applicable wire		22 to 14 AWG: 0.3 to 2.0mm ² (when solderless terminals are used)
Installation method	Screw		M4 × 0.7mm × 12mm or more
			Tightening torque range: 78 to 118N·cm (8 to 12kgf·cm, 7 to 10lbf·in)
	DIN rail		Applicable DIN rail: TH35-7.5Fe, TH35-7.5Al (compliant with IEC 60715)
Withstand voltage			500VAC for 1 minute
Insulation resistance (initial)			10MΩ or more (measured with 500VDC insulation resistance tester)
Weight			Approx. 160g

*1: Evaluation for UL certification is conducted using a resistive load.

3-2. FA-TB32XYL, FA-TB32XYH

Item		Model	FA-TB32XYL, FA-TB32XYH
Number of I/O points, I/O device numbers			32 points, X0 to X1F or Y0 to Y1F (Current consumption of "Display of power supply" and "Display of 0 to 1F signal":4mA/1 point at DC24V)
Rated voltage			24VDC (CLASS 2)
Maximum operating voltage			28.8VDC (CLASS 2)
Maximum operating current*1			Signal: 1A, Common: 2A
Terminal block	Terminal block screw		M3 screw, number of terminals: 34P, 7.62mm pitch, spring-up screw with finger protection cover
			Tightening torque range: 58.8 to 88.2N·cm (6 to 9kgf·cm, 5.22 to 7.5lbf·in), UL standard conformity tightening torque: 59N·cm, 5.22 lbf·in
	Applicable wire		22 to 14 AWG: 0.3 to 2.0mm ² (when solderless terminals are used)
Installation method	Screw		M4 × 0.7mm × 20mm or more
			Tightening torque range: 78 to 118N·cm (8 to 12kgf·cm, 7 to 10lbf·in)
	DIN rail		Applicable DIN rail: TH35-7.5Fe, TH35-7.5Al (compliant with IEC 60715)
Withstand voltage			500VAC for 1 minute
Insulation resistance (initial)			10MΩ or more (measured with 500VDC insulation resistance tester)
Weight			Approx. 200g

*1: Evaluation for UL certification is conducted using a resistive load.

3-3. FA-TB32XYP3, FA-TB32XYN3

Item		Model	FA-TB32XYP3	FA-TB32XYN3
Number of I/O points, I/O device numbers			32 points, X0 to X1F or Y0 to Y1F	
Rated voltage			24VDC (CLASS 2)	
Maximum operating voltage			28.8VDC (CLASS 2)	
Maximum operating current*1			Signal: 1A, Common: 2A	
Wiring method for common			32 points / 16 common(24VDC)	32 points / 16 common(0VDC)
Terminal block	Terminal block screw		M3 screw, number of terminals: 50P, 7.62mm pitch, spring-up screw with finger protection cover	
			Tightening torque range: 58.8 to 88.2N·cm (6 to 9kgf·cm, 5.22 to 7.5lbf·in), UL standard conformity tightening torque: 59N·cm, 5.22 lbf·in	
	Applicable wire		22 to 14 AWG: 0.3 to 2.0mm ² (when solderless terminals are used)	
Installation method	Screw		M4 × 0.7mm × 12mm or more	
			Tightening torque range: 78 to 118N·cm (8 to 12kgf·cm, 7 to 10lbf·in)	
	DIN rail		Applicable DIN rail: TH35-7.5Fe, TH35-7.5Al (compliant with IEC 60715)	
Withstand voltage			500VAC for 1 minute	
Insulation resistance (initial)			100MΩ or more (measured with 500VDC insulation resistance tester)	
Weight			Approx. 280g	

*1: Evaluation for UL certification is conducted using a resistive load.

3-4. FA-TBS32XY

Item		Model	FA-TBS32XY
Number of I/O points, I/O device numbers			32 points, X0 to X1F or Y0 to Y1F
Rated voltage			24VDC (CLASS 2)
Maximum operating voltage			28.8VDC (CLASS 2)
Maximum operating current*1			Signal: 1A, Common: 2A
Terminal block	Terminal block screw		M3 screw, Number of terminals : 34P, 7mm pitch, with screw retention/drop prevention mechanism
			Tightening torque range: 43 to 58N·cm(4.4 to 5.9kgf·cm, 3.81 to 5.13lbf·in), UL standard conformity tightening torque: 50N·cm, 4.43lbf·in
	Applicable wire		22 to 16 AWG: 0.3 to 1.25mm ² (when solderless terminals are used)
Installation method	Screw		M4 × 0.7mm × 25mm or more
			Tightening torque range: 78 to 118N·cm (8 to 12kgf·cm, 7 to 10lbf·in)
	DIN rail		Applicable DIN rail: TH35-7.5Fe, TH35-7.5Al (compliant with IEC 60715)
Withstand voltage			500VAC for 1 minute
Insulation resistance (initial)			10MΩ or more (measured with 500VDC insulation resistance tester)
Weight			Approx. 150g

*1: Evaluation for UL certification is conducted using a resistive load.

3-5. FA-TBS40P

Item		Model	FA-TBS40P
Number of I/O points			40 points
Rated voltage			24VDC (CLASS 2)
Maximum operating voltage			48VDC (CLASS 2)
Maximum operating current ^{*1}			Signal: 1A
Terminal block	Terminal block screw		M3 screw, Number of terminals : 40P, 7mm pitch, with screw retention/drop prevention mechanism
			Tightening torque range: 43 to 58N·cm(4.4 to 5.9kgf·cm, 3.81 to 5.13lbf·in), UL standard conformity tightening torque: 50N·cm, 4.43lbf·in
	Applicable wire		22 to 16 AWG: 0.3 to 1.25mm ² (when solderless terminals are used)
Installation method	Screw		M4 × 0.7mm × 25mm or more
			Tightening torque range: 78 to 118N·cm (8 to 12kgf·cm, 7 to 10lbf·in)
	DIN rail		Applicable DIN rail: TH35-7.5Fe, TH35-7.5Al (compliant with IEC 60715)
Withstand voltage			500VAC for 1 minute
Insulation resistance (initial)			10MΩ or more (measured with 500VDC insulation resistance tester)
Weight			Approx. 190g

*1: Evaluation for UL certification is conducted using a resistive load.

3-6. FA-TB1L32XY

Item		Model	FA-TB1L32XY
Number of I/O points, I/O device numbers			32 points, X0 to X1F or Y0 to Y1F
Rated voltage			24VDC (CLASS 2)
Maximum operating voltage			28.8VDC (CLASS 2)
Maximum operating current ^{*1}			Signal: 1A, Common: 2A
Terminal block	Terminal block screw		M3.5 screw, Number of terminals : 34P, 8mm pitch (center: 9mm), screw holding mechanism
			Tightening torque range: 70 to 110N·cm(7.2 to 11.2kgf·cm, 6.2 to 9.7lbf·in)
	Applicable wire		24 to 14 AWG: 0.3 to 2.0mm ² (when solderless terminals are used)
Installation method	Screw		M4 × 0.7mm × 12mm or more
			Tightening torque range: 78 to 118N·cm (8 to 12kgf·cm, 7 to 10lbf·in)
	DIN rail		Applicable DIN rail: TH35-7.5Fe, TH35-7.5Al (compliant with IEC 60715)
Withstand voltage			500VAC for 1 minute
Insulation resistance (initial)			100MΩ or more (measured with 500VDC insulation resistance tester)
Weight			Approx. 230g

*1: Evaluation for UL certification is conducted using a resistive load.

3-7. FA-LEB32XY, FA-LEB32XY-3, FA-LEB32XY-3A

Item		Model	FA-LEB32XY	FA-LEB32XY-3	FA-LEB32XY-3A
Number of I/O points, I/O device numbers		32 points, X0 to X1F or Y0 to Y1F			
Rated voltage		24VDC (CLASS 2)			
Maximum operating voltage		28.8VDC (CLASS 2)			
Maximum operating current ^{*1}		Signal: 1A, Common: 2A			
e-CON connector		4-wire connector		3-wire connector	3-wire connector
		1P:24VDC, 2P:NC, 3P:0V, 4P:X/Y		1P:24VDC, 2P:0V, 3P:X/Y	1P:24VDC, 2P:X/Y, 3P:0V
		Applicable wire: 0.14 to 0.5mm ² (20 to 26 AWG) Completion external form ϕ 0.8 to 2.0mm(Initial contact resistance: 50m Ω or less)			
		Wiring method for common : 32point / 32common(24VDC), 32point / 32common(0VDC)			
Terminal block	Terminal block screw	M3 screw, number of terminals: 2P, spring-up screw with finger protection cover			
	Applicable wire	Tightening torque range: 58.8 to 88.2N·cm (6 to 9kgf·cm, 5.22 to 7.5lbf·in), UL standard conformity tightening torque: 59N·cm, 5.22 lbf·in			
Installation method	Screw	M4 × 0.7mm × 10mm or more			
		Tightening torque range: 78 to 118N·cm (8 to 12kgf·cm, 7 to 10lbf·in)			
	DIN rail	Applicable DIN rail: TH35-7.5Fe, TH35-7.5Al (compliant with IEC 60715)			
Withstand voltage		500VAC for 1 minute			
Insulation resistance (initial)		10M Ω or more (measured with 500VDC insulation resistance tester)			
Weight		Approx. 105g	Approx. 100g		

*1: Evaluation for UL certification is conducted using a resistive load.

4. CONNECTABLE MODULES AND CABLES

4-1. FA-TB32XY, FA-TBS32XY, FA-TB1L32XY, FA-LEB32XY, FA-LEB32XY-3, FA-LEB32XY-3A

Module model for a programmable controller		Cable model	Module model	
MELSEC iQ-R series connector type	RX41C4	At positive common	FA-CBL**FMV	
	RX42C4	At negative common	FA-CBL**FMVE	
	RY41NT2P RY42NT2P		FA-CBL**FMV	
	RY41PT1P RY42PT1P		FA-CBL**FMV	
	RH42C4NT2P	Input side: positive common	FA-CBL**FMV	
		Input side: negative common	FA-CBL**FMVE	
Output side		FA-CBL**FMV		
MELSEC-Q series connector type	QX41 QX41-S1 QX41-S2 QX42 QX42-S1		FA-CBL**FMV	
	QX71 ^{*1, *2} QX72 ^{*1, *2}	At positive common At negative common	FA-CBL**FMV FA-CBL**FMVE	
	QX81 QX81-S2		FA-CBL**DMFX	
	QX82 QX82-S1		FA-CBL**FMVE	
	QY41P ^{*2} QY41H ^{*1, *2} QY42P ^{*2} QY71 ^{*1, *2}		FA-CBL**FMV	
	QY81P ^{*2}		FA-CBL**DMFY	
	QY82P ^{*2}		FA-CBL**FMV	
	QH42P QX41Y41P ^{*2}		FA-CBL**FMV	
	MELSEC-L series connector type	LX41C4	At positive common	FA-CBL**FMV
		LX42C4	At negative common	FA-CBL**FMVE
LY41NT1P LY42NT1P			FA-CBL**FMV	
LY41PT1P LY42PT1P			FA-CBL**FMV	
LH42C4NT1P LH42C4PT1P		Input side: positive common	FA-CBL**FMV	
		Input side: negative common	FA-CBL**FMVE	
	Output side	FA-CBL**FMV		
CC-Link connector type	AJ65SBTCF1-32D AJ65BTC1-32D NZ2GFCF1-32D	At positive common	FA-CBL**FMH FA-FCBL**FMH	
	AJ65SBTCF1-32T ^{*2} AJ65BTC1-32T ^{*2} NZ2GFCF1-32T ^{*2}		FA-CBL**FMH FA-FCBL**FMH	

FA-TB32XY
FA-TBS32XY
FA-TB1L32XY
FA-LEB32XY
FA-LEB32XY-3
FA-LEB32XY-3A

*1: When using with a 5VDC power supply, connect it to a 24VDC terminal.

*2: When using with a 12VDC power supply, connect it to a 24VDC terminal.

4-2. FA-TB32XYL, FA-TB32XYH

Module model for a programmable controller*1		Cable model	Module model		
MELSEC iQ-R series connector type	RX41C4	At positive common	FA-CBL**FMV	FA-TB32XYL	
	RX42C4	At negative common	FA-CBL**FMVE	FA-TB32XYH	
	RY41NT2P RY42NT2P		FA-CBL**FMV	FA-TB32XYL	
	RY41PT1P RY42PT1P		FA-CBL**FMV	FA-TB32XYH	
	RH42C4NT2P	Input side: positive common	FA-CBL**FMV	FA-TB32XYL	
		Input side: negative common	FA-CBL**FMVE	FA-TB32XYH	
Output side		FA-CBL**FMV	FA-TB32XYL		
MELSEC-Q series connector type	QX41 QX41-S1 QX41-S2 QX42 QX42-S1		FA-CBL**FMV	FA-TB32XYL	
	QX81 QX81-S2		FA-CBL**DMFX	FA-TB32XYH	
	QX82 QX82-S1		FA-CBL**FMVE		
	QY41P QY41H QY42P QY71		FA-CBL**FMV	FA-TB32XYL	
	QY81P		FA-CBL**DMFY	FA-TB32XYH	
	QY82P		FA-CBL**FMV		
	QH42P QX41Y41P		FA-CBL**FMV	FA-TB32XYL	
	MELSEC-L series connector type	LX41C4	At positive common	FA-CBL**FMV	FA-TB32XYH
		LX42C4	At negative common	FA-CBL**FMVE	
		LY41NT1P LY42NT1P		FA-CBL**FMV	FA-TB32XYL
LY41PT1P LY42PT1P			FA-CBL**FMV	FA-TB32XYH	
LH42C4NT1P		Input side: positive common	FA-CBL**FMV	FA-TB32XYL	
		Input side: negative common	FA-CBL**FMVE	FA-TB32XYH	
		Output side	FA-CBL**FMV	FA-TB32XYL	
LH42C4PT1P		Input side: positive common	FA-CBL**FMV	FA-TB32XYL	
	Input side: negative common	FA-CBL**FMVE	FA-TB32XYH		
	Output side	FA-CBL**FMV	FA-TB32XYH		
CC-Link connector type	AJ65SBTCF1-32D AJ65BTC1-32D NZ2GFCF1-32D	At positive common	FA-CBL**FMH FA-FCBL**FMH	FA-TB32XYL	
	AJ65SBTCF1-32T AJ65BTC1-32T NZ2GFCF1-32T		FA-CBL**FMH FA-FCBL**FMH		

*1: For use with 24VDC only.

4-3. FA-TB32XYP3, FA-TB32XYN3

Module model for a programmable controller		Cable model	Module model		
MELSEC iQ-R series connector type	RX41C4	At positive common	FA-CBL**FMV	FA-TB32XYN3	
	RX42C4	At negative common	FA-CBL**FMVE	FA-TB32XYP3	
	RY41NT2P		FA-CBL**FMV	FA-TB32XYP3	
	RY42NT2P		FA-CBL**FMV	FA-TB32XYP3	
	RY41PT1P		FA-CBL**FMV	FA-TB32XYN3	
	RY42PT1P		FA-CBL**FMV	FA-TB32XYN3	
MELSEC-Q series connector type	RH42C4NT2P	Input side: positive common	FA-CBL**FMV	FA-TB32XYN3	
		Input side: negative common	FA-CBL**FMVE	FA-TB32XYP3	
		Output side	FA-CBL**FMV	FA-TB32XYP3	
MELSEC-Q series connector type	QX41		FA-CBL**FMV	FA-TB32XYN3	
	QX41-S1		FA-CBL**FMV		
	QX41-S2		FA-CBL**FMV	FA-TB32XYP3	
	QX42		FA-CBL**FMVE		
	QX42-S1		FA-CBL**DMFX	FA-TB32XYP3	
	QX81		FA-CBL**DMFX		
	QX81-S2		FA-CBL**DMFX	FA-TB32XYP3	
	QX82		FA-CBL**FMVE		
	QX82-S1		FA-CBL**FMVE	FA-TB32XYP3	
	QY41P ^{*2}		FA-CBL**FMV		
QY41H ^{*1,*2}		FA-CBL**FMV	FA-TB32XYP3		
QY42P ^{*2}		FA-CBL**FMV			
QY71 ^{*1,*2}		FA-CBL**FMV	FA-TB32XYP3		
QY81P ^{*2}		FA-CBL**DMFY			
QY82P ^{*2}		FA-CBL**FMV	FA-TB32XYN3		
MELSEC-L series connector type	QH42P	Input side	FA-CBL**FMV	FA-TB32XYN3	
	QX41Y41P ^{*2}	Output side	FA-CBL**FMV	FA-TB32XYP3	
MELSEC-L series connector type	LX41C4	At positive common	FA-CBL**FMV	FA-TB32XYN3	
	LX42C4	At negative common	FA-CBL**FMVE	FA-TB32XYP3	
	LY41NT1P		FA-CBL**FMV	FA-TB32XYP3	
	LY42NT1P		FA-CBL**FMV	FA-TB32XYP3	
	LY41PT1P		FA-CBL**FMV	FA-TB32XYN3	
	LY42PT1P		FA-CBL**FMV	FA-TB32XYN3	
	LH42C4NT1P		Input side: positive common	FA-CBL**FMV	FA-TB32XYN3
			Input side: negative common	FA-CBL**FMVE	FA-TB32XYP3
			Output side	FA-CBL**FMV	FA-TB32XYP3
	LH42C4NT1P		Input side: positive common	FA-CBL**FMV	FA-TB32XYN3
		Input side: negative common	FA-CBL**FMVE	FA-TB32XYP3	
		Output side	FA-CBL**FMV	FA-TB32XYP3	
CC-Link connector type	AJ65SBTCF1-32D	At positive common	FA-CBL**FMH	FA-TB32XYN3	
	AJ65BTC1-32D		FA-FCBL**FMH		
CC-Link connector type	AJ65SBTCF1-32T ^{*2}		FA-CBL**FMH	FA-TB32XYP3	
	AJ65BTC1-32T ^{*2}		FA-FCBL**FMH		
	NZ2GFCF1-32T ^{*2}		FA-FCBL**FMH		

*1: When using with a 5VDC power supply, connect it to a 24VDC terminal.

*2: When using with a 12VDC power supply, connect it to a 24VDC terminal.

4-4. FA-TBS40P

Module model for a programmable controller		Cable model	Module model
MELSEC iQ-R series connector type	RX41C4 RX42C4	FA-CBL**FMV-M	FA-TBS40P
	RY41NT2P RY42NT2P	FA-CBL**FMV-M	
	RY41PT1P RY42PT1P	FA-CBL**FMV-M	
	RH42C4NT2P	FA-CBL**FMV-M	
MELSEC-Q series connector type	QX41 QX41-S1 QX41-S2 QX42 QX42-S1	FA-CBL**FMV-M	
	QX71 ^{*1,*2} QX72 ^{*1,*2}	FA-CBL**FMV-M	
	QX82 QX82-S1	FA-CBL**FMV-M	
	QY41P ^{*2} QY41H ^{*1,*2} QY42P ^{*2} QY71 ^{*1,*2}	FA-CBL**FMV-M	
	QY82P ^{*2}	FA-CBL**FMV-M	
	QH42P QX41Y41P ^{*2}	FA-CBL**FMV-M	
MELSEC-L series connector type	LX41C4 LX42C4	FA-CBL**FMV-M	
	LY41NT1P LY42NT1P	FA-CBL**FMV-M	
	LY41PT1P LY42PT1P	FA-CBL**FMV-M	
	LH42C4NT1P LH42C4PT1P	FA-CBL**FMV-M	
	CC-Link connector type	AJ65SBTCF1-32D AJ65BTC1-32D NZ2GFCF1-32D	
AJ65SBTCF1-32T ^{*2} AJ65BTC1-32T ^{*2} NZ2GFCF1-32T ^{*2}		FA-CBL**FMH-M	
AJ65SBTCF1-32DT NZ2GFCF1-32DT		FA-CBL**FMH-M	
AJ65VBTCF1-32DT1		FA-CBL**FMV-M	

*1: When using with a 5VDC power supply, connect it to a 24VDC terminal.

*2: When using with a 12VDC power supply, connect it to a 24VDC terminal.

5. EXTERNAL DIMENSIONS

5-1. FA-TB32XY

[Unit : mm]

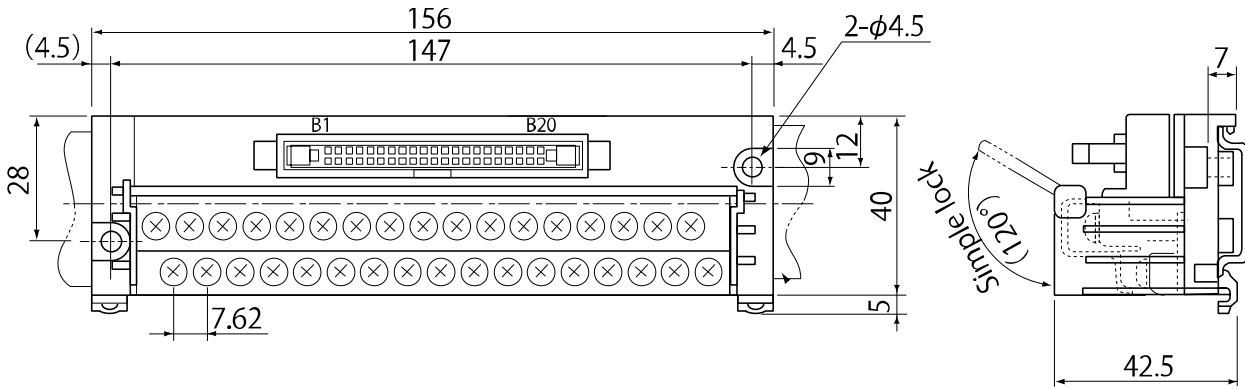

5-2. FA-TB32XYL/H

[Unit : mm]

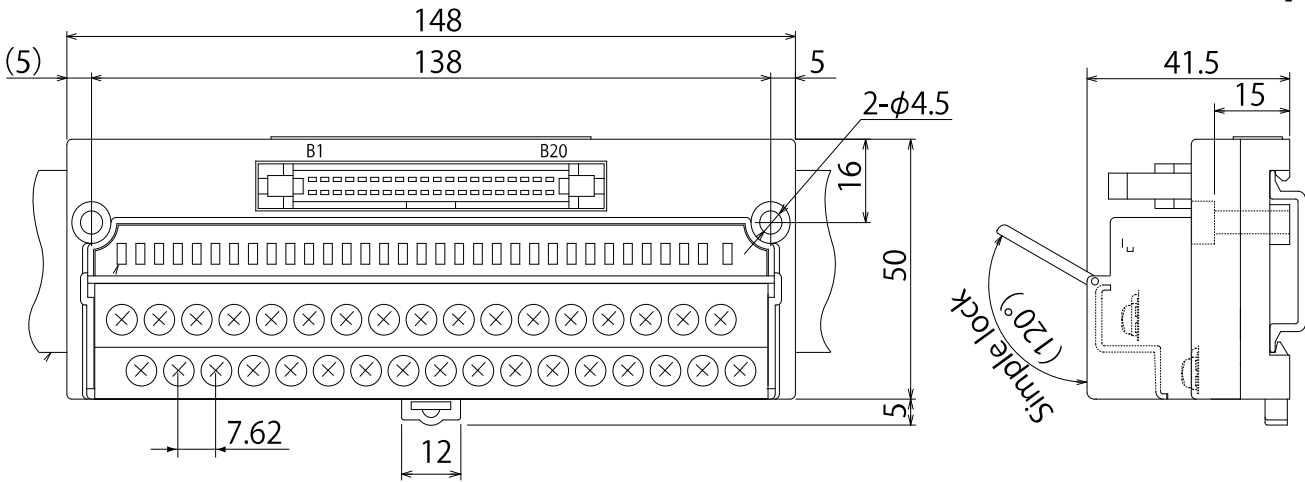

5-3. FA-TB32XYP3, FA-TB32XYN3

[Unit : mm]

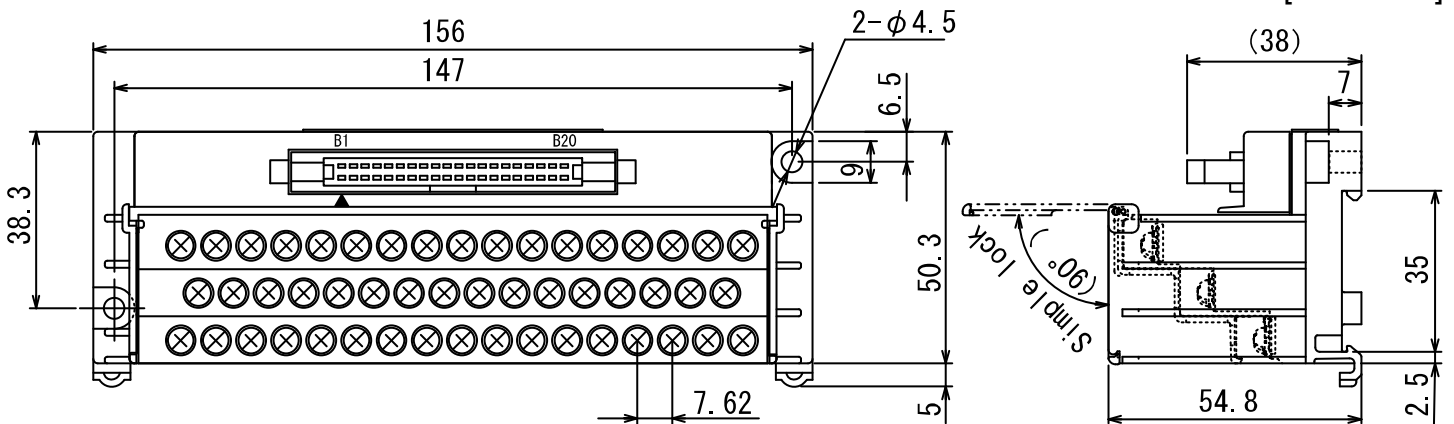

5-4. FA-TBS32XY

[Unit : mm]

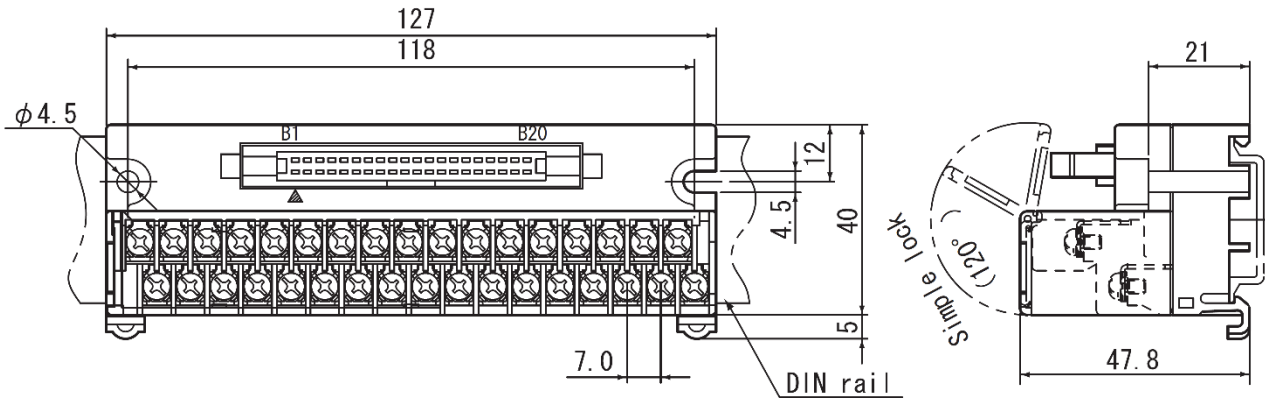

5-5. FA-TBS40P

[Unit : mm]

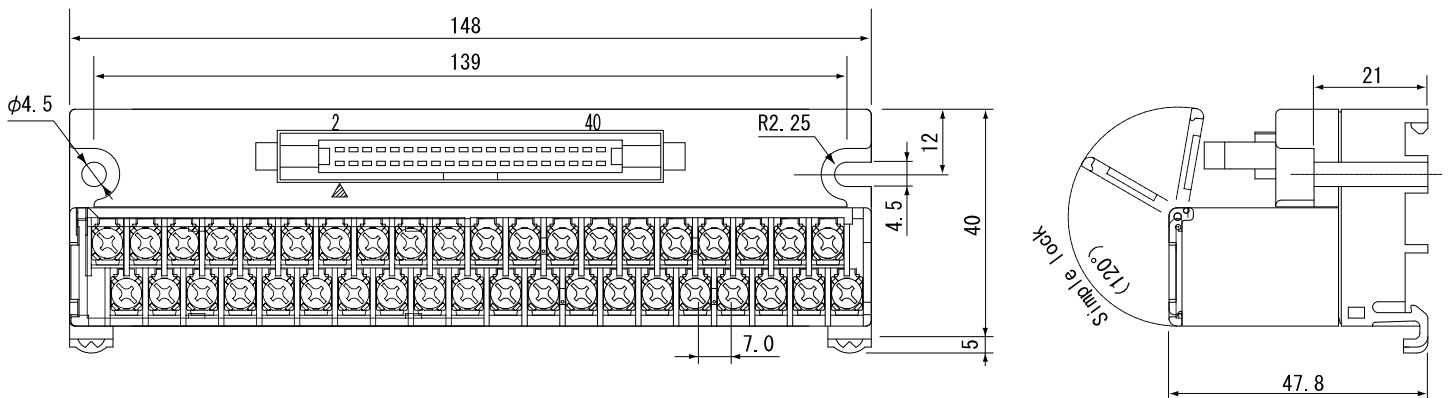

5-6. FA-TB1L32XY

[Unit : mm]

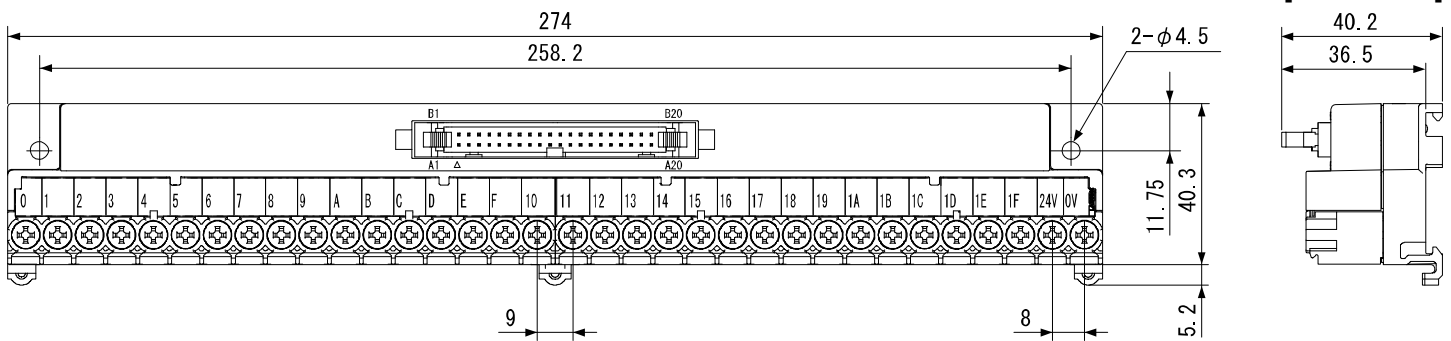

5-7. FA-LEB32XY, FA-LEB32XY-3, FA-LEB32XY-3A

[Unit : mm]

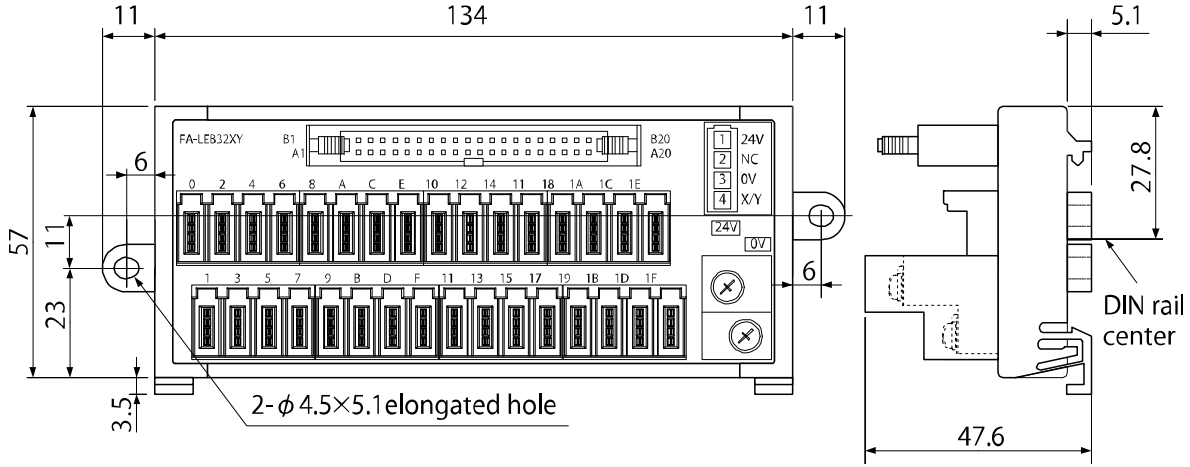

6. CONNECTING METHOD

6-1. Connection example with a connector module of a programmable controller

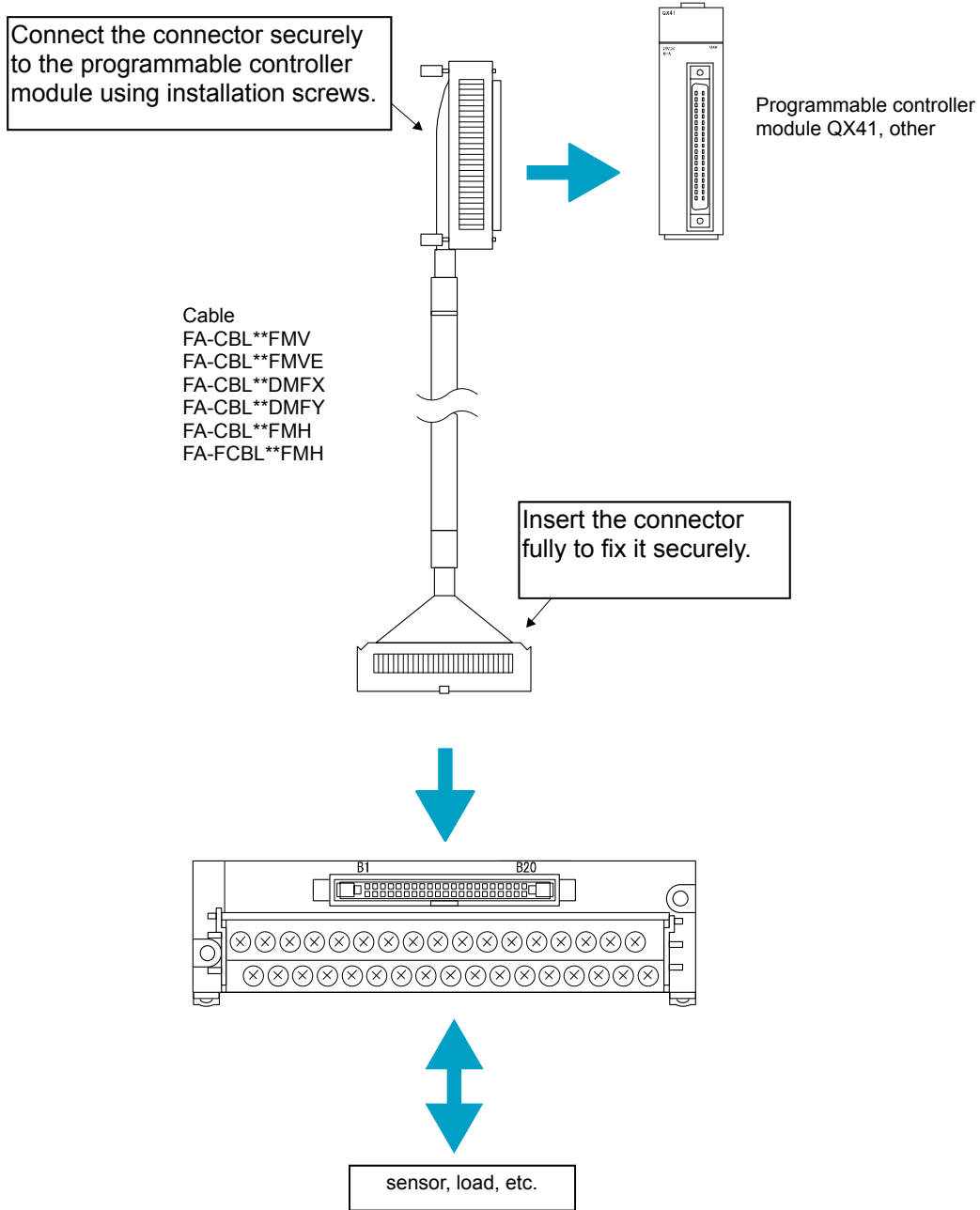

6-2. When connecting a 40P connector module of a non-Mitsubishi programmable controller (FA-TBS40P)

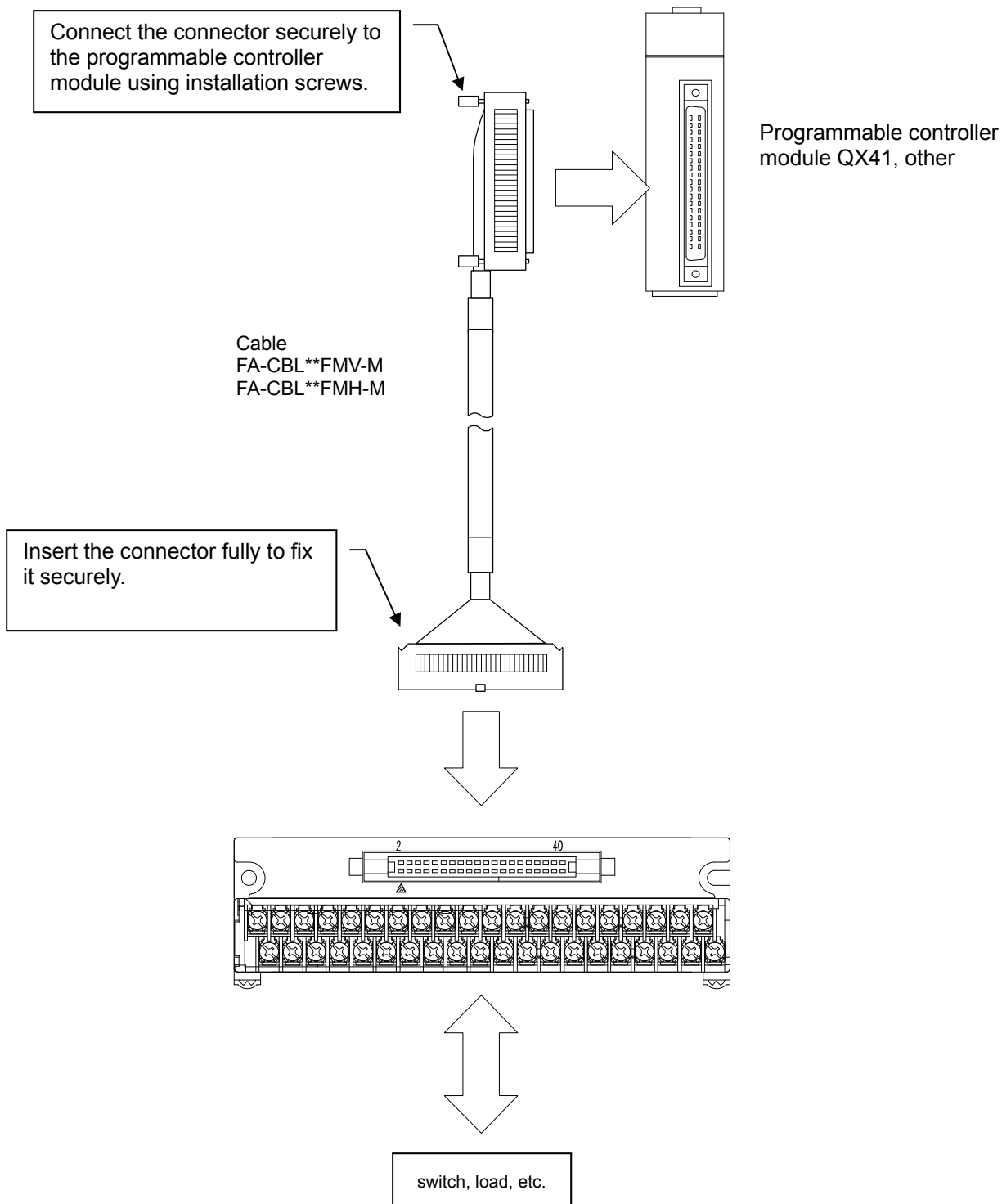

7. EXTERNAL CONNECTION EXAMPLE

7-1. FA-TB32XY, FA-TBS32XY

(1) When the positive common input module connection

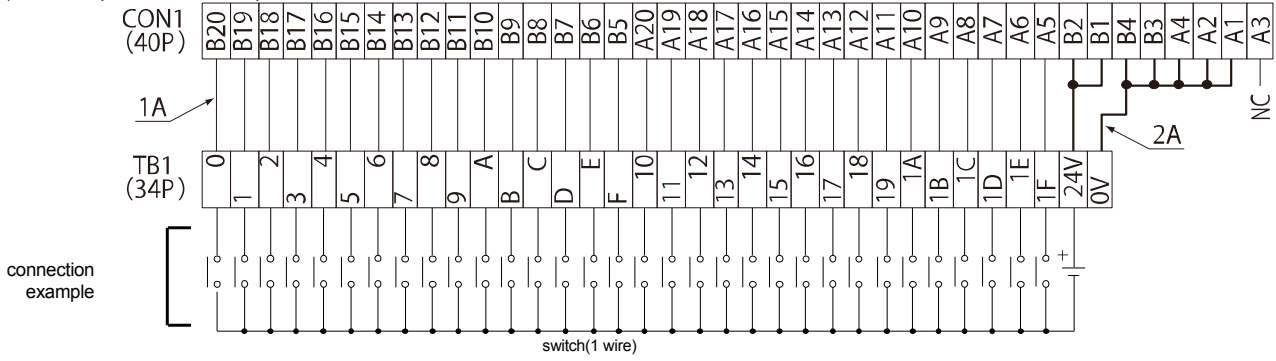

(2) When the negative common input module connection

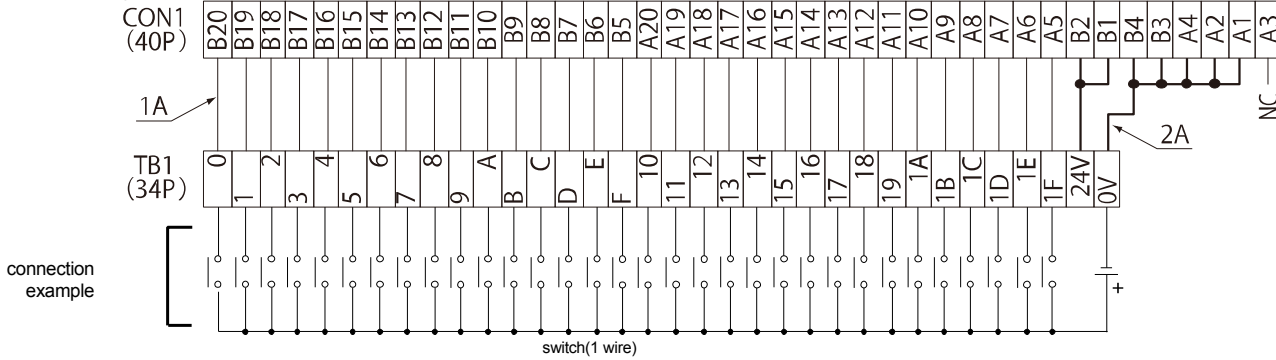

(3) When the sink output module connection

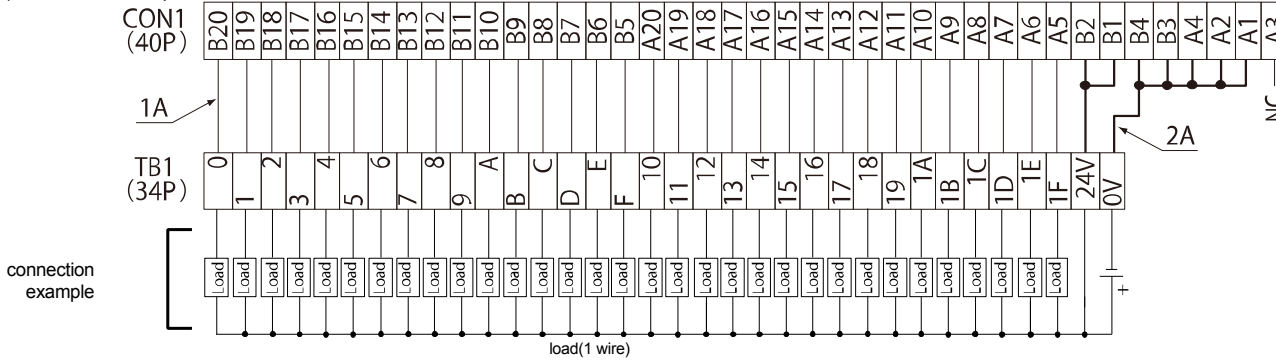

(4) When the source output module connection

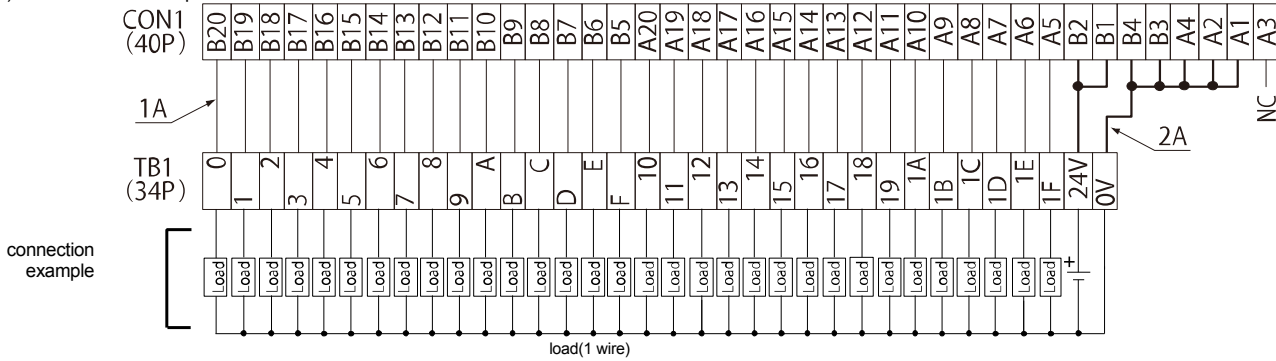

7-2. FA-TB32XYL

(1) When the positive common input module connection

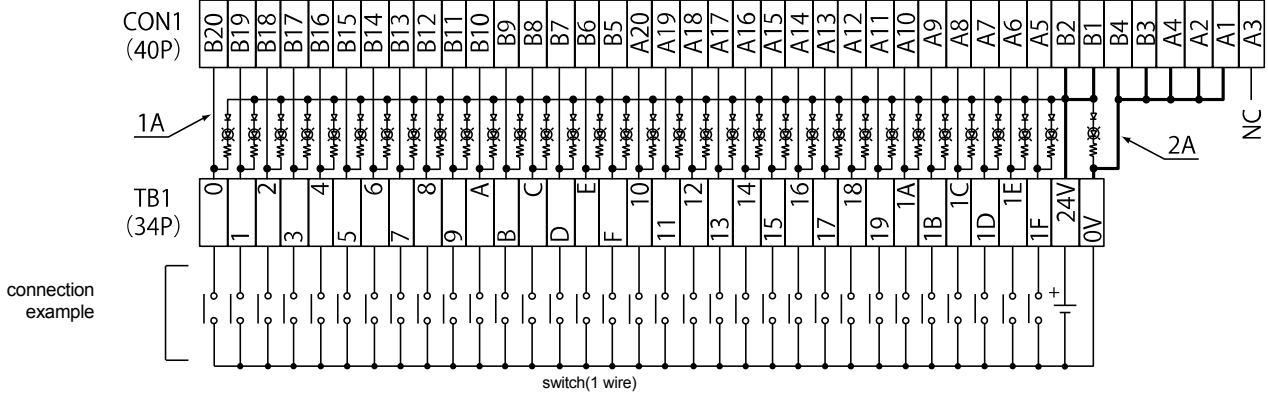

(2) When the sink output module connection

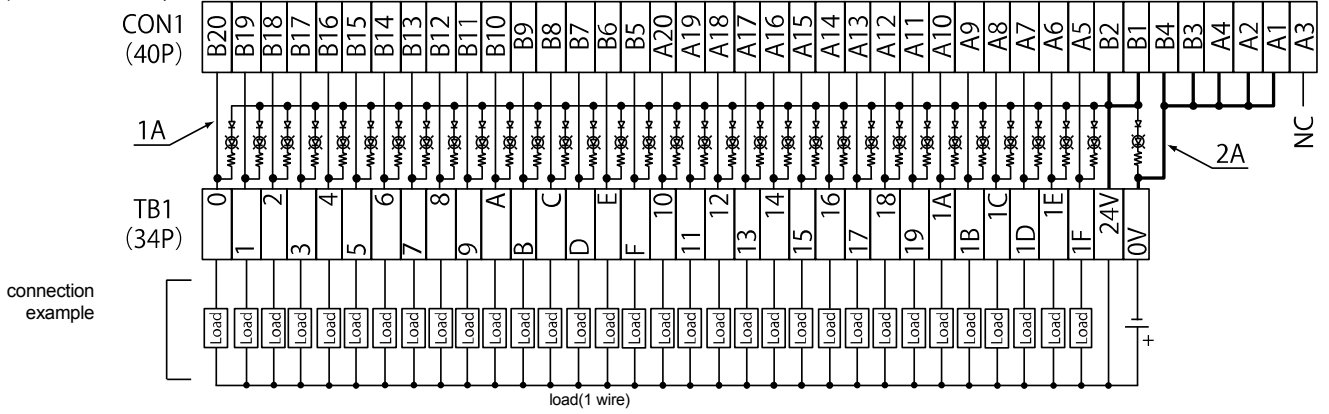

7-3. FA-TB32XYH

(1) When the negative common input module connection

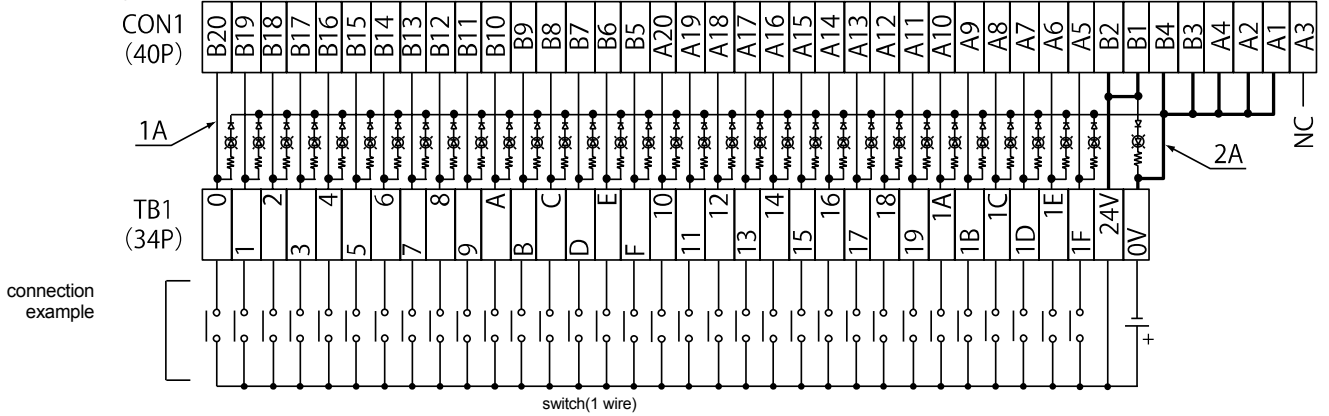

(2) When the source output module connection

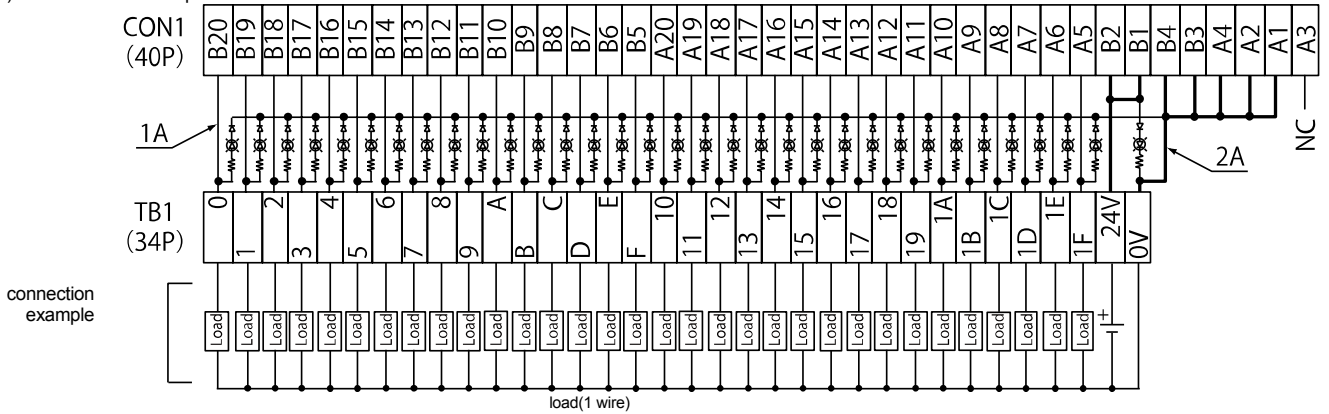

7-6. FA-TBS40P

(1) When the positive common input module connection

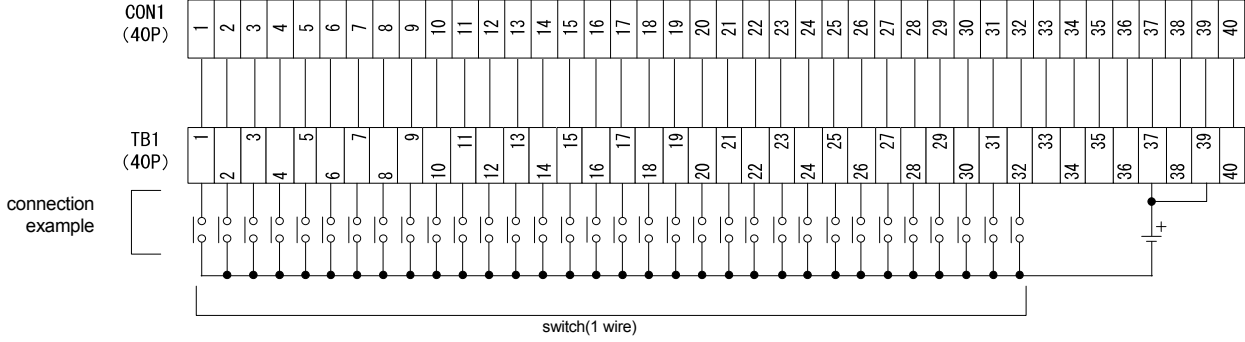

(2) When the negative common input module connection

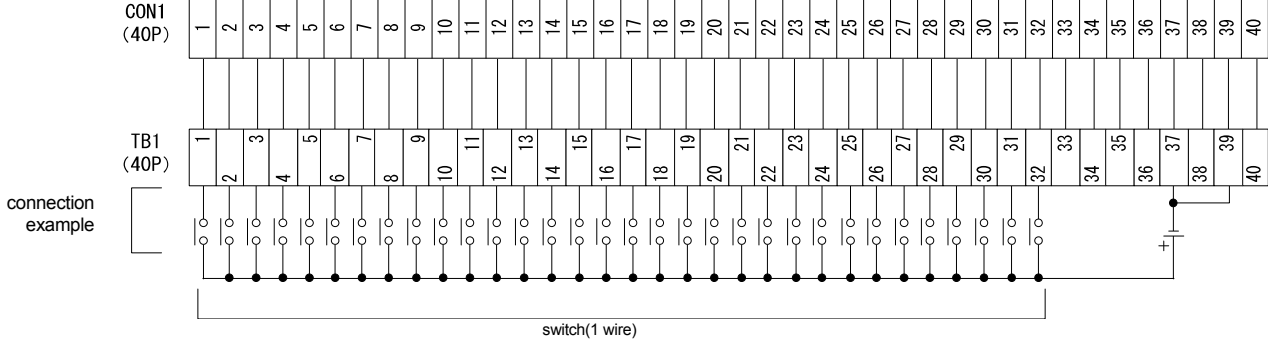

(3) When the sink output module connection

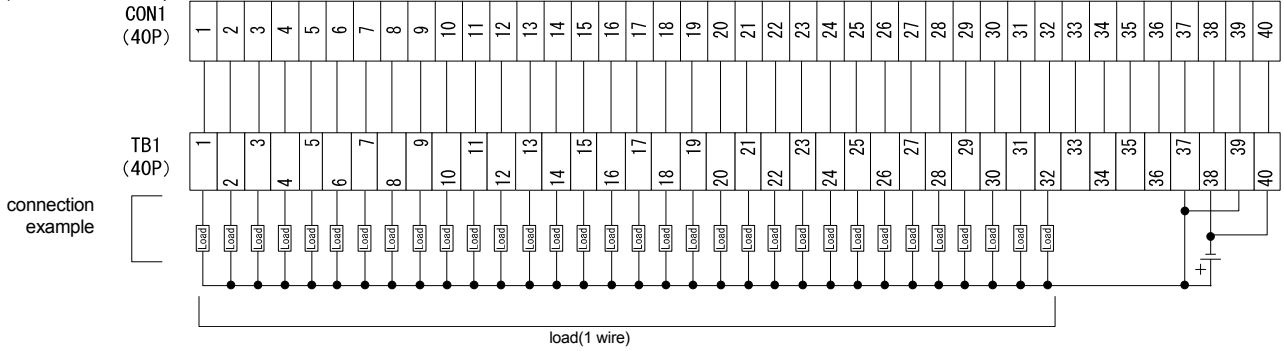

(4) When the source output module connection

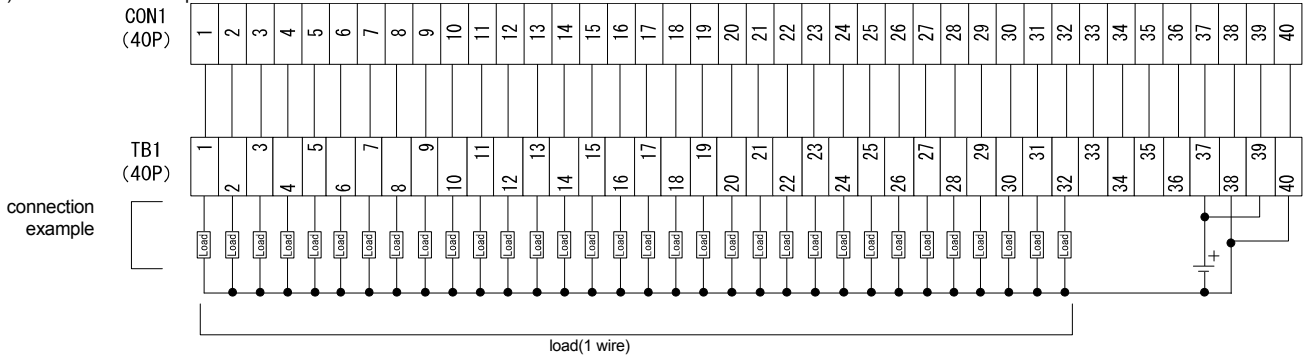

7-7. FA-TB1L32XY

(1) When the positive common input module connection

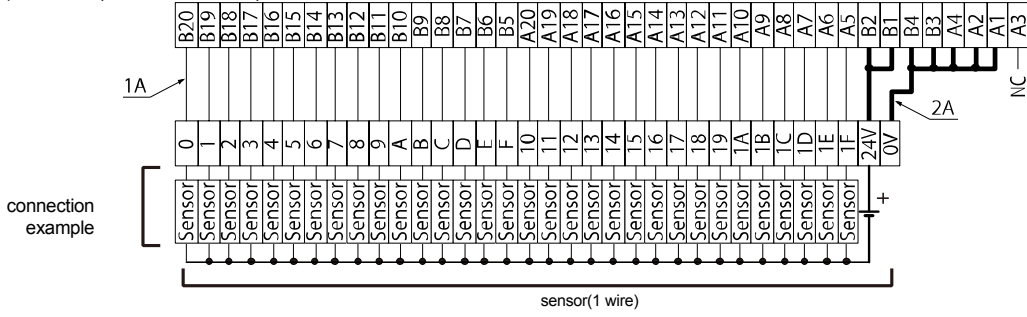

(2) When the negative common input module connection

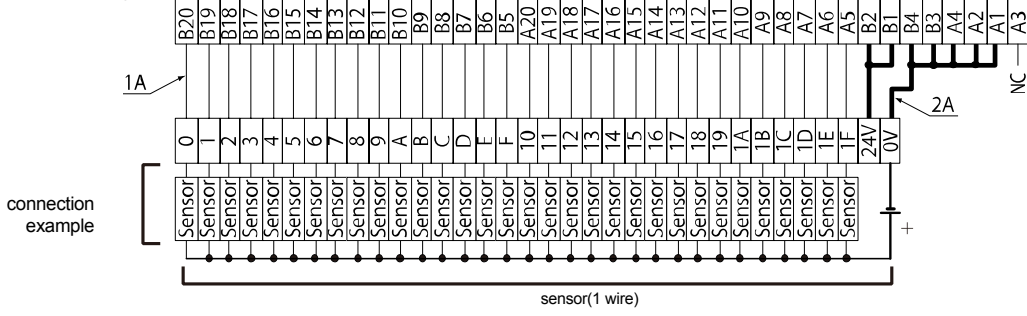

(3) When the sink output module connection

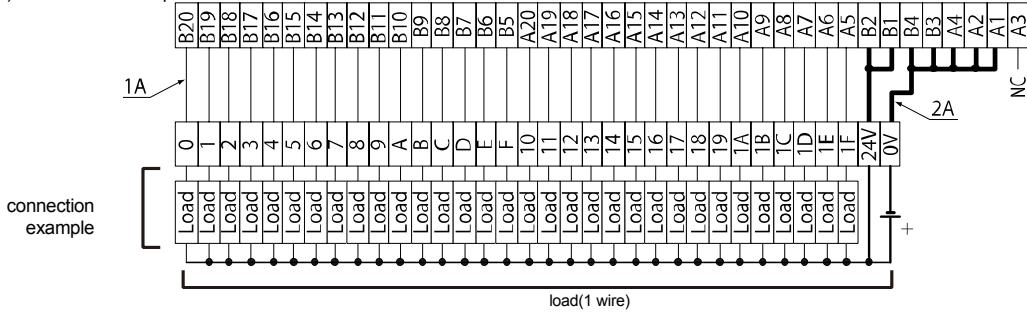

(4) When the source output module connection

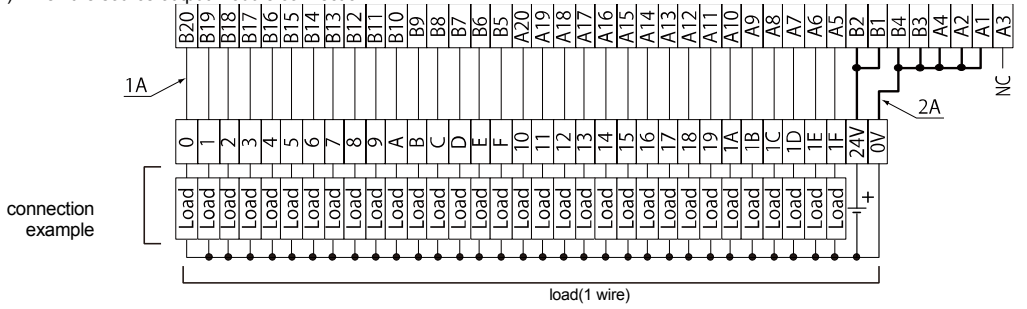

7-8. FA-LEB32XY

(1) When the positive common input module connection

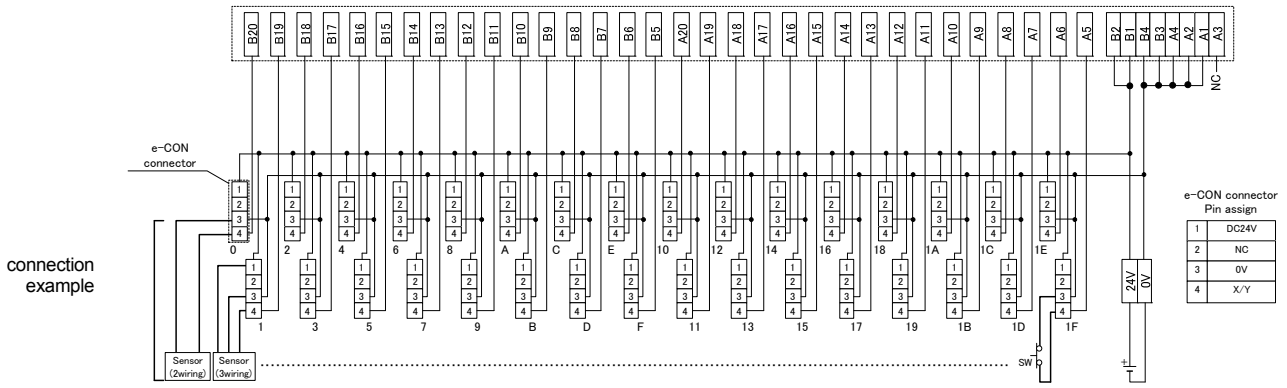

(2) When the negative common input module connection

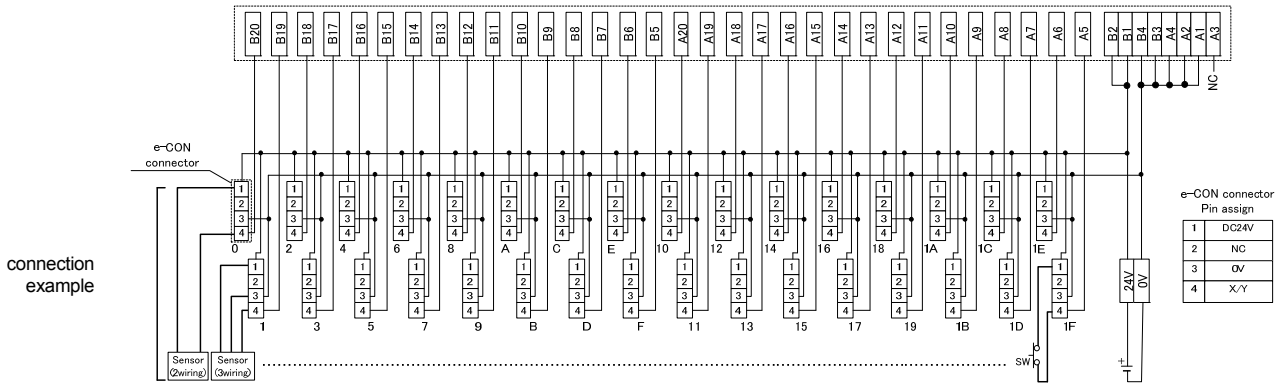

(3) When the sink output module connection

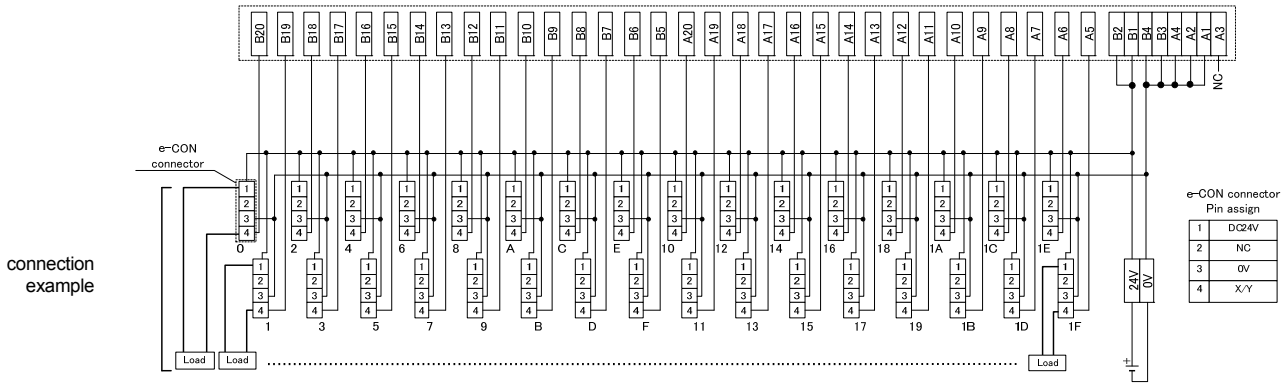

(4) When the source output module connection

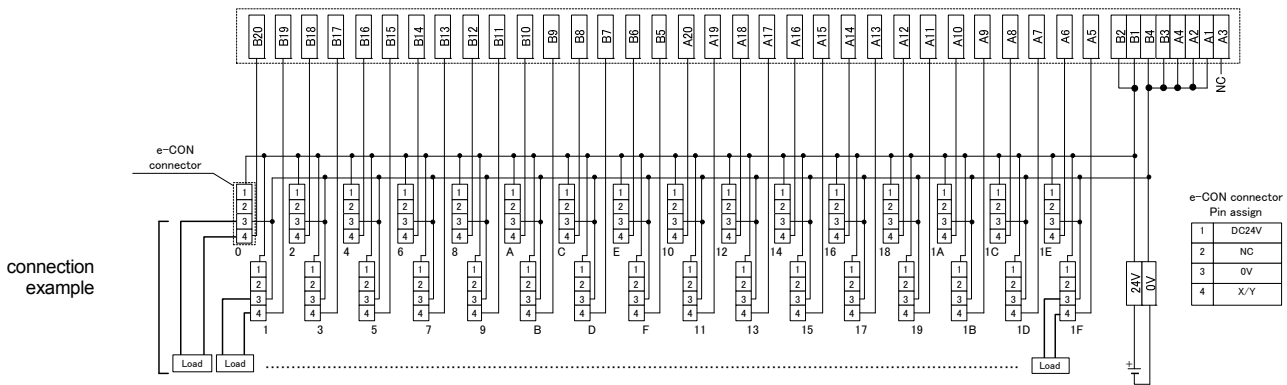

7-9. FA-LEB32XY-3

(1) When the positive common input module connection

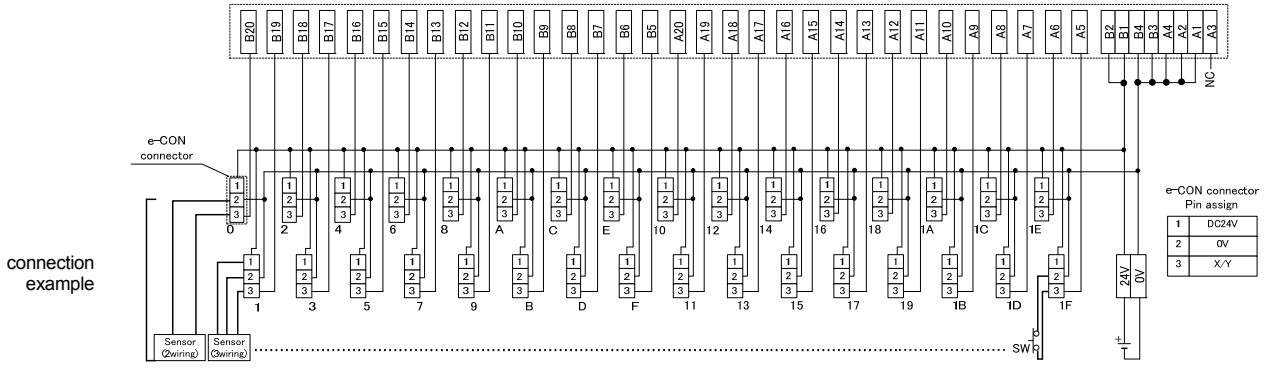

(2) When the negative common input module connection

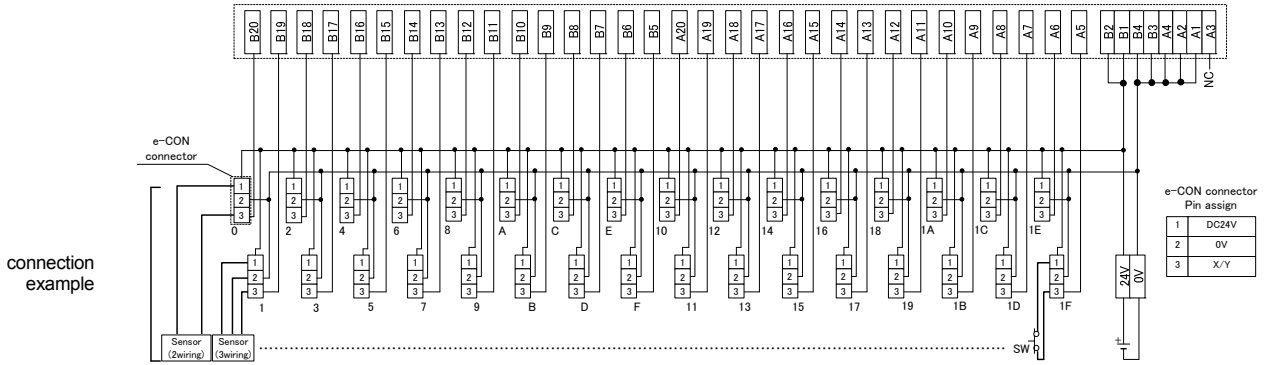

(3) When the sink output module connection

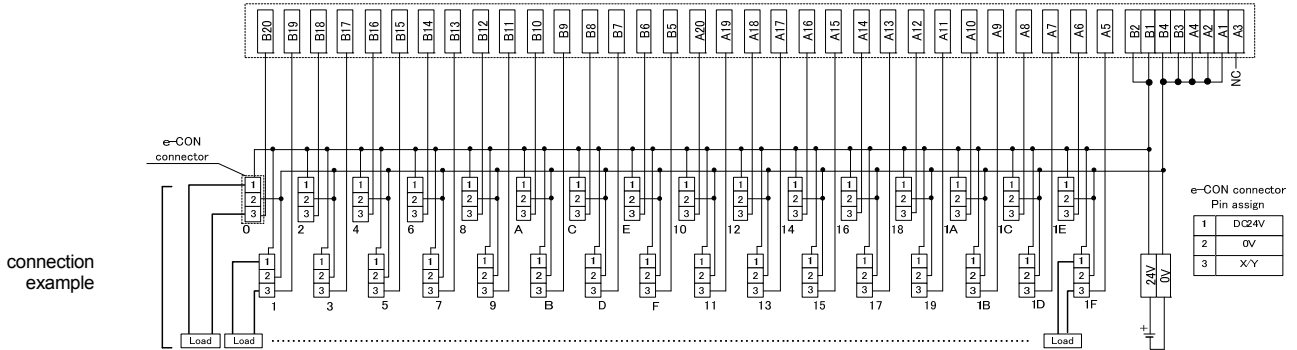

(4) When the source output module connection

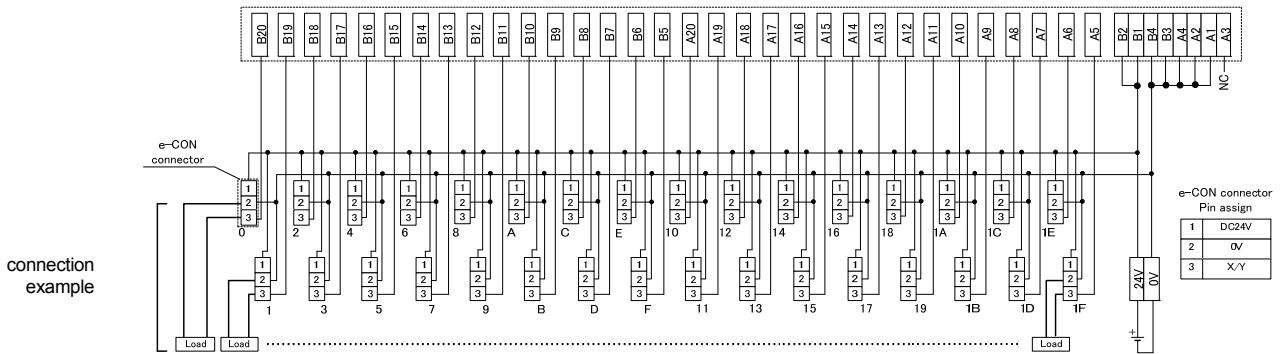

7-10. FA-LEB32XY-3A

(1) When the positive common input module connection

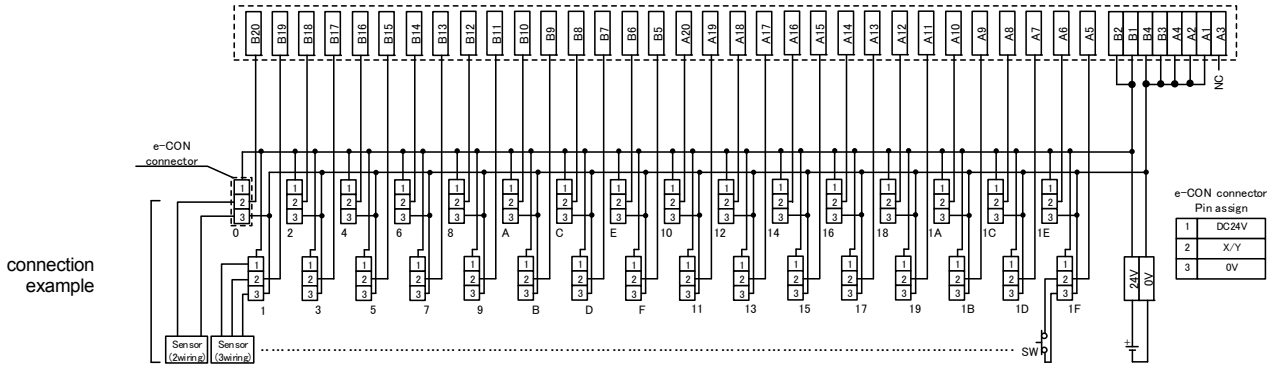

(2) When the negative common input module connection

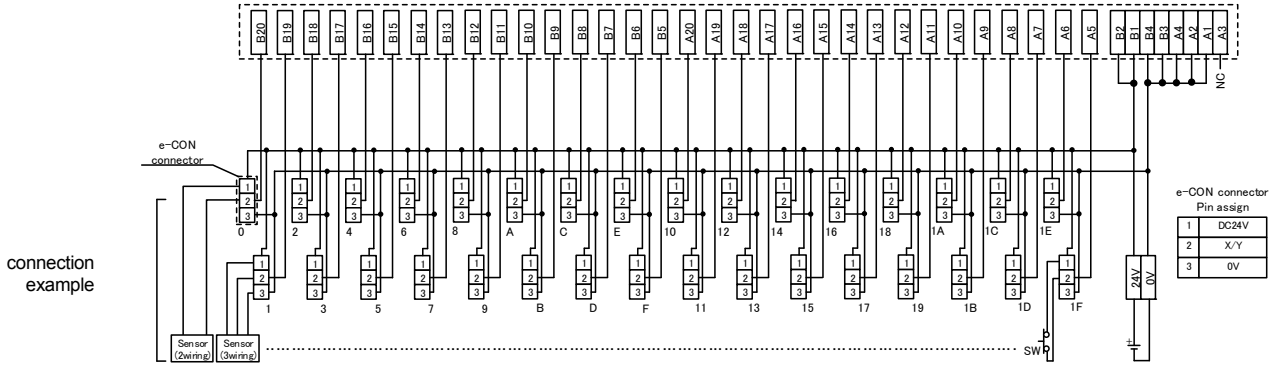

(3) When the sink output module connection

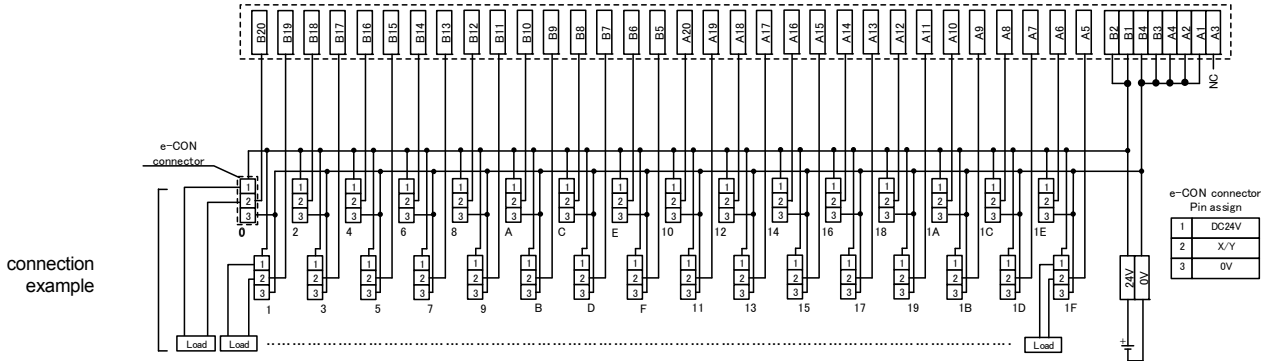

(4) When the source output module connection

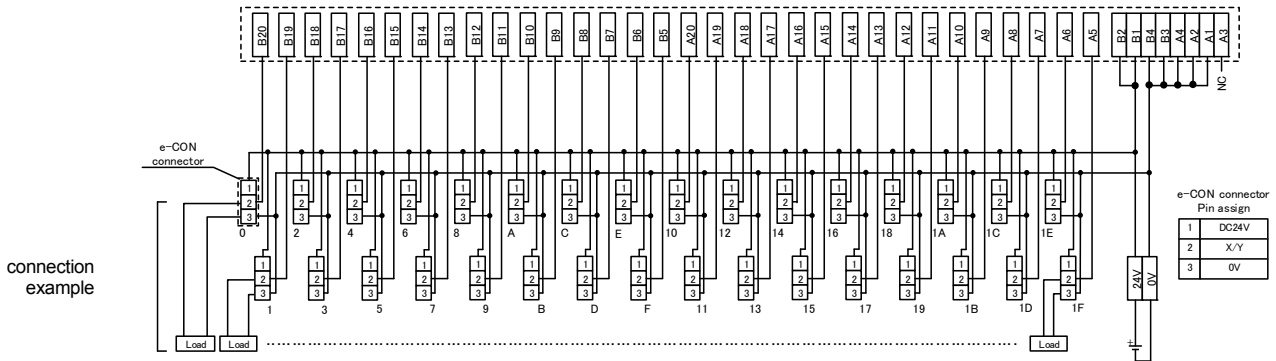

8. APPLICABLE SOLDERLESS TERMINALS

8-1. FA-TB32XY, FA-TB32XYL/H, FA-TB32XYP3/N3, FA-LEB32XY, FA-LEB32XY-3/3A

Type		Round		Y-shaped	
Manufacture	Applicable wire size	Non-insulated solderless terminal	Insulated solderless terminal	Non-insulated solderless terminal	Insulated solderless terminal
Nichifu Co., Ltd. NTM	0.3 to 1.25mm ²	R1.25-3N R1.25-3.5N	TG _N ^V 1.25-3N TG _N ^V 1.25-3.5N	1.25Y-3 1.25Y-3N 1.25Y-3L 1.25Y-3.5	TG _N ^V 1.25Y-3 TG _N ^V 1.25Y-3N TG _N ^V 1.25Y-3L TG _N ^V 1.25Y-3.5
	1.25 to 2.0mm ²	R2-3N	TG _N ^V 2-3N	2Y-3 2Y-3.5S	TG _N ^V 2Y-3 TG _N ^V 2Y-3.5S
Japan Solderless Terminal Mfg. Co., Ltd. JST	0.3 to 1.25mm ²	1.25-MS3	V1.25-MS3	1.25-B3A 1.25-C3A 1.25-N3A 1.25-C3.5A	V1.25-B3A V1.25-N3A
	1.25 to 2.0mm ²	2-MS3	V2-MS3	2-N3A 2-M3A	V2-N3A
Nippon Tanshi Co., Ltd. NTK	0.3 to 1.25mm ²	R1.25-3ML R1.25-3.5SL	RAV1.25-3ML RAP1.25-3ML	VD1.25-3L VD1.25-3.5SS VD1.25-3.5S	VDAV1.25-3L VDAV1.25-3.5SS VDAV1.25-3.5S
	1.25 to 2.0mm ²	R2-3SL	RAV2-3SL RAP2-3SL	VD2-3S VD2-3.5SS VD2-3.5S	VDAV2-3.5SS VDAV2-3.5S

• Solderless terminal dimensions

[Unit : mm]

Round non-insulated solderless terminal

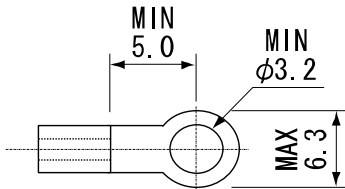

Round insulated solderless terminal

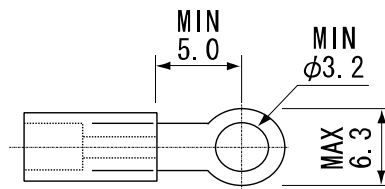

Y-shaped non-insulated solderless terminal

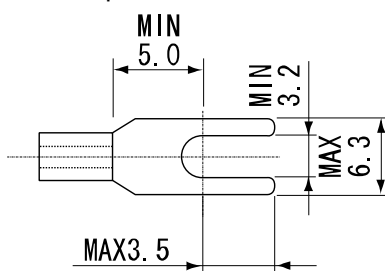

Y-shaped insulated solderless terminal

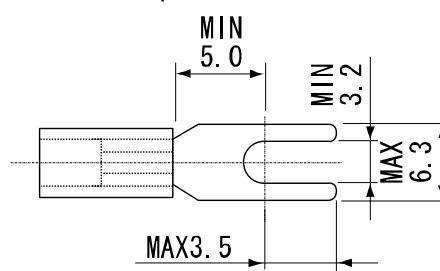

• Terminal block shape

[Unit : mm]

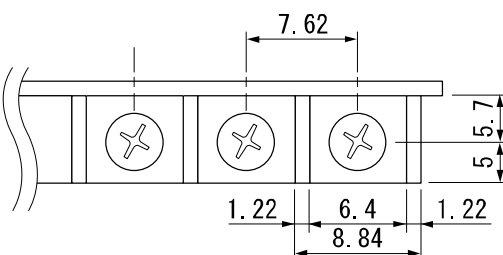

8-2. FA-TBS32XY, FA-TBS40P

Type		Round		Y-shaped	
Manufacture	Applicable wire size	Non-insulated solderless terminal	Insulated solderless terminal	Non-insulated solderless terminal	Insulated solderless terminal
Nichifu Co., Ltd. NTM	0.3 to 1.25mm ²	R1.25-3N R1.25-3.5N	TMEV1.25-3 TMEV1.25-3N TMEV1.25-3.5N TG _N ^Y 1.25-3N TG _N ^Y 1.25-3.5N	1.25Y-3 1.25Y-3N 1.25Y-3.5	TMEV1.25Y-3 TMEV1.25Y-3K TMEV1.25Y-3.5 TMEV1.25Y-3.5K TG _N ^Y 1.25Y-3 TG _N ^Y 1.25Y-3N TG _N ^Y 1.25Y-3.5
Japan Solderless Terminal Mfg. Co., Ltd. JST	0.3 to 1.25mm ²	1.25-MS3	V1.25-MS3	1.25-B3A 1.25-C3A 1.25-C3.5A	V1.25-B3A
Nippon Tanshi Co., Ltd. NTK	0.3 to 1.25mm ²	R1.25-3ML R1.25-3.5SL	RAV1.25-3ML RAP1.25-3ML	VD1.25-3L VD1.25-3.5SS	VDAV1.25-3L VDAV1.25-3.5SS

• Solderless terminal dimensions

[Unit : mm]

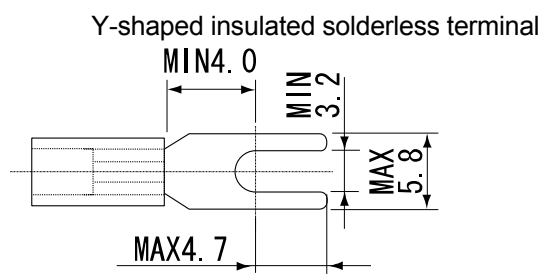
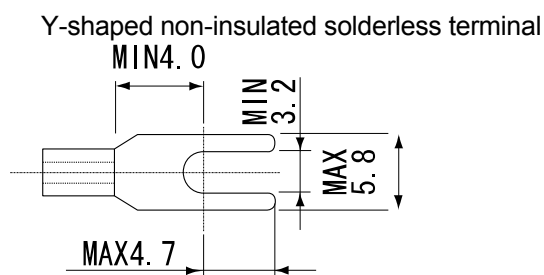
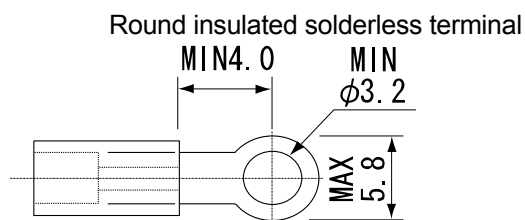
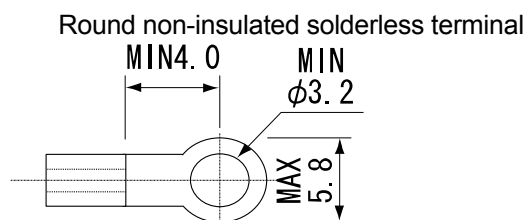

• Terminal block shape

[Unit : mm]

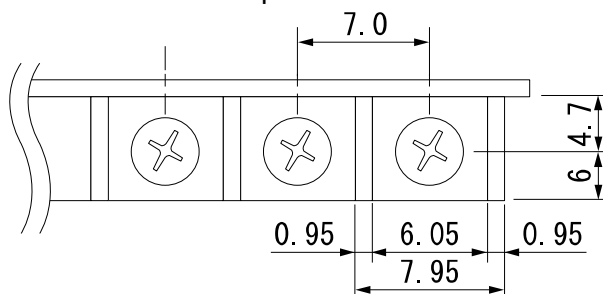

8-3. FA-TB1L32XY

Type		Round		Y-shaped	
Manufacture	Applicable wire size	Non-insulated solderless terminal	Insulated solderless terminal	Non-insulated solderless terminal	Insulated solderless terminal
Nichifu Co., Ltd. NTM	0.3 to 1.25mm ²	R1.25-3.5	TG _N 1.25-3.5	1.25Y-3.5	TG _N 1.25Y-3.5
	1.25 to 2.0mm ²	R2-3.5	TG _N 2-3.5	2Y-3.5	TG _N 2Y-3.5
Japan Solderless Terminal Mfg. Co., Ltd. JST	0.3 to 1.25mm ²	R1.25-3.5	V1.25-M3	1.25-YS3A	V1.25-YS3A
	1.25 to 2.0mm ²	R2-3.5	V2-M3	2-YS3A	V2-YS3A
Nippon Tanshi Co., Ltd. NTK	0.3 to 1.25mm ²	R1.25-3.5	RAV1.25-3.5	VD1.25-3.5S	VDAV1.25-3.5S
	1.25 to 2.0mm ²	R2-3.5	RAV2-3.5	VD2-3.5S	VDAV2-3.5S

• Solderless terminal dimensions

[Unit : mm]

Round non-insulated solderless terminal

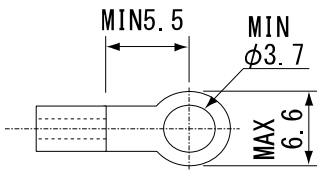

Round insulated solderless terminal

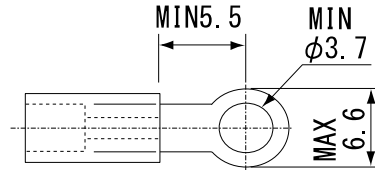

Y-shaped non-insulated solderless terminal

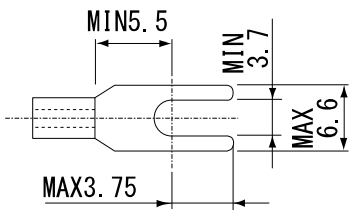

Y-shaped insulated solderless terminal

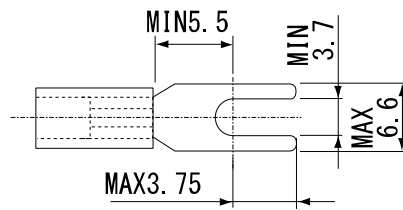

• Terminal block shape

[Unit : mm]

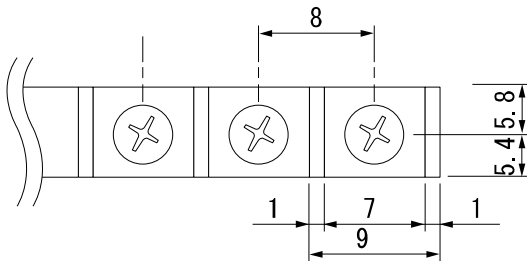

9. PRECAUTIONS

- (1) For wiring to the terminal block, refer to the manual of the programmable controller module to be connected, published by Mitsubishi Electric.

10. GRATIS WARRANTY TERMS AND GRATIS WARRANTY RANGE

If any fault or defect (hereinafter referred to as "Failure") attributable to Mitsubishi Electric Engineering should occur within the gratis warranty period, Mitsubishi Electric Engineering shall replace the product free of charge via the distributor from whom you made your purchase.

- Gratis warranty period

The gratis warranty period of this product shall be one (1) year from the date of purchase or delivery to the designated place.

- Gratis warranty range

(1) The gratis warranty range shall be limited to normal use based on the usage conditions, methods and environment, etc., defined by the terms and precautions, etc., given in the instruction manual, user's manual, and caution labels on the product.

(2) In the following cases, a repair fee shall be applied even if within the gratis warranty period.

- 1) Failure resulting from inappropriate storage or handling, carelessness or negligence by the user, or Failure caused by the user's hardware or software design.
- 2) Failure caused by unapproved modifications, etc., to the product by the user.
- 3) Failure that could have been avoided if, when the Mitsubishi Electric Engineering product was assembled into the user's device, safeguards defined by legal regulations applicable to the user's device or functions or structures considered standard by the industry had been provided.
- 4) Failure recognized as preventable if the consumed products specified in instruction manuals, etc., were normally maintained or replaced.
- 5) Replacement of consumable parts (relays, etc.).
- 6) Failure caused by external factors beyond anyone's control such as fires or abnormal voltage, and Failure caused by Force Majeure such as earthquakes, lightning, or wind and water damage.
- 7) Failure caused by reasons unpredictable by scientific technology standards at the time of shipment from Mitsubishi Electric Engineering.
- 8) Any other failure not attributable to Mitsubishi Electric Engineering or found by the user to not be attributable to Mitsubishi Electric Engineering.

11. EXCLUSION FROM LIABILITY FOR OPPORTUNITY LOSS AND SECONDARY LOSS

Regardless of the gratis warranty period, Mitsubishi Electric Engineering shall not be liable for compensation for damages arising from causes not attributable to Mitsubishi Electric Engineering, opportunity losses or lost profits incurred by the user due to Failures of Mitsubishi Electric Engineering products, damages or secondary damages arising from special circumstances, whether foreseen or unforeseen by Mitsubishi Electric Engineering, compensation for accidents, compensation for damages to products other than Mitsubishi Electric Engineering products, or compensation for replacement work, readjustment of onsite machinery and equipment, startup test runs or other duties carried out by the user.

12. TRADEMARKS

MELSEC, MELSEC iQ-R, CC-Link, CC-Link IE, and CC-Link L/T are trademarks or registered trademarks of Mitsubishi Electric Corporation. Other company names and product names in the text are trademarks or registered trademarks of each company.

In some cases, trademark symbols such as '™' or '®' are not specified in this manual.



FOR SAFE OPERATIONS

- This product has been manufactured as a general-purpose part for general industries, and has not been designed or manufactured to be incorporated in a device or system used in purposes related to human life.
- Before using the product for special purposes such as nuclear power, electric power, aerospace, medicine or passenger movement vehicles, consult with Mitsubishi Electric Engineering.
- This product has been manufactured under strict quality control. However, when installing the product where major accidents or losses could occur if the product fails, install appropriate backup or failsafe functions in the system.

mitsubishi electric engineering company limited

1-13-5 Kudankita, Chiyoda-ku, Tokyo, Japan 102-8404

Specifications subject to change without notice.

50D-FG0229

Published in March 2018