

Mitsubishi **General-Purpose** Programmable Controller  
Renewal Tool

Base Adapter  
Models:  
**ERNT-ASQB38N-S1**

User's Manual

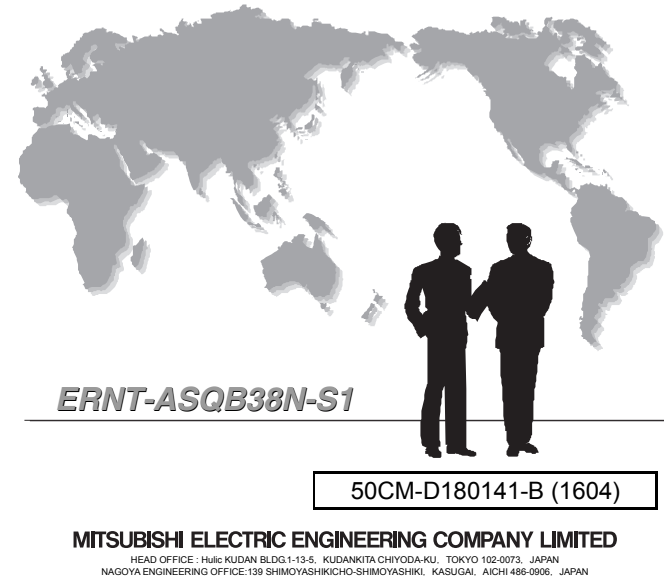

**【Installation Precautions】**

**⚠ WARNING**

- Before attempting to install the Unit, make certain that the external power supply, used in the system, is shut off on all three phases. Failure to do so may result in electric shock or damage to the product.

---

**⚠ CAUTION**

- Use the Base Adapter in the environmental conditions that are specified in the general specification contained in the user's manual supplied with the MELSEC-Q Series CPU Module. If the Products are used in any environment beyond the bounds of the general specification, electric shock, fire, malfunction, or damage to or degradation of the Products will result.
- Fasten the Base Adapter and the MELSEC-Q Series Base Unit securely with retaining screws, and tighten the screws by applying torque within specified limits. Loose screws can lead to the dropping of the Base Adapter or MELSEC-Q Series Base Unit, possibly causing breakage thereof. Excessive tightness of the screws can lead to breakage of the screws, Base Adapter or MELSEC-Q Series Base Unit, possibly causing the dropping.

**【Startup and Maintenance Precautions】**

**⚠ WARNING**

- Shut off the external power supply for the system in all phases before cleaning or retightening the terminal screws. Failure to do so may result in electric shock. Loose screws can lead to dropping, shorting, and malfunction. Excessive tightness of the screws can lead to breakage of the screws, Base Adapter, or MELSEC-Q Series Module, possibly causing the dropping, shorting, and malfunction thereof.

**⚠ CAUTION**

- Do not drop the Base Adapter or do not give a strong impact to it. This will cause damage.

**【Disposal Precautions】**

**⚠ CAUTION**

- When disposing of the product, treat it as industrial waste.

**【启动和维护注意事项】**

**⚠ 警告**

- 在清洁模块或重新紧固安装螺钉时，必须将系统使用的外部电源全部断开后再进行操作。如果未全部断开，有可能导致触电。如果螺钉拧得过松，有可能导致掉落、短路或误动作。如果螺钉拧得过紧，有可能会造成螺钉、基板适配器和MELSEC-Q系列基本模块破损，从而导致掉落、短路或误动作。

---

**⚠ 注意**

- 请勿使基板适配器掉落或受到强烈撞击。否则可能导致破损。

**【废弃注意事项】**

**⚠ 注意**

- 废弃时请将本产品作为工业废弃物处理。

**3. Mounting and Installation**

- 3.1 Handling Instructions**
- (1) Before attempting to install the Unit, make certain that the external power supply, used in the system, is shut off on all three phases.
  - (2) Fasten the Base Adapter and the MELSEC-Q Series Base Unit securely with retaining screws, and tighten the screws by applying torque within specified limits. Loose screws can lead to the dropping of the Base Adapter or MELSEC-Q Series Base Unit, possibly causing breakage thereof. Excessive tightness of the screws can lead to breakage of the screws, Base Adapter or MELSEC-Q Series Base Unit, possibly causing the dropping.
  - (3) Do not drop the Base Adapter or do not give a strong impact to it. This will cause damage.

**3.2 Instruction for use**

Item	Description
Extension cable	For the extension cable that connects the main base unit and the extension base unit, use QC06B (0.6m) or longer cables.  extension cable (QC06B or longer)
Depth dimension	The depth dimension increases by 16mm. Check dimensional data before installation. 【MELSEC-AnS series】  Main base unit A1S38B 16mm Base Adapter ERNT-ASQB38N-S1 (QA1S51B mounting portion) Extension base unit QA1S51B

● SAFETY PRECAUTIONS ●

(Always read these precautions prior to use.)

Before using this product, please read this manual carefully and pay full attention to safety to ensure that the product is used correctly.  
The precautions presented in this manual are concerned with this product only. For Programmable Controller system safety precautions, refer to the user's manual of the MELSEC-Q series CPU module to be used.  
In this manual, the safety precautions are ranked as "WARNING" and "CAUTION."

<b>⚠ WARNING</b>	Indicates that incorrect handling may cause hazardous conditions, resulting in death or severe injury.
<b>⚠ CAUTION</b>	Indicates that incorrect handling may cause hazardous conditions, resulting in medium or minor injury and/or property damage.

Note that failure to observe the **⚠ CAUTION** level instructions may lead to a serious consequence according to the circumstances. Always follow the precautions of both levels because they are important to personal safety.  
Please keep this manual in an easy-to-access location for future reference, and be sure to provide the manual to the end user.

**【Precautions before using】**

**⚠ CAUTION**

- When making a switch from the MELSEC-A Series to the MELSEC-Q Series, be sure to consult user's manual supplied with individual module under the MELSEC-Q Series to confirm differences in various aspects including performance and function between the two series.

● 安全注意事项 ●

(使用前请务必阅读)

使用本产品时，请仔细阅读本手册，并充分注意安全，正确地使用产品。本手册中注明的注意事项仅记载了与本产品相关的内容。关于可编程控制器系统的安全注意事项，请参阅所使用的MELSEC-Q系列CPU模块的用户手册。在本●安全注意事项●中，安全注意事项的等级分为「警告」和「注意」。

<b>⚠ 警告</b>	表示错误操作可能造成危险后果，引起死亡或重伤事故。
<b>⚠ 注意</b>	表示错误操作可能造成危险后果，引起中度伤害、轻伤及财产损失。

另外，根据情况不同，即使是**⚠注意**中记载的事项，也可能引发严重后果。不管哪个记载的都是非常重要的内容，请务必遵守。请妥善保管本手册，以便需要时取阅，并请本手册交给最终用户。

**【使用前的注意事项】**

**⚠ 注意**

- 从MELSEC-AnS系列替换至MELSEC-Q系列时，为确认性能和功能等方面的差异，请务必参照MELSEC-Q系列的各模块的手册进行使用。

**【安装注意事项】**

**⚠ 警告**

- 请务必切断系统使用的所有相的外部供给电源后进行安装。如果不切断所有相的电源，可能会触电或造成产品损坏。

**⚠ 注意**

- 应在MELSEC-Q系列CPU模块用户手册中记载的一般规格环境下使用基板适配器。如果在一般规格范围以外的环境中使用基板适配器，可能导致触电、火灾、误动作、产品损坏或性能劣化。
- 基板适配器及MELSEC-Q系列基板应通过安装螺钉切实加以固定，安装螺钉应在规定的扭矩范围内切实地拧紧。如果螺钉拧得过松，有可能因掉落而导致基板适配器及MELSEC-Q系列基板破损。如果螺钉拧得过紧，有可能造成螺钉、基板适配器及MELSEC-Q系列基板破损，从而导致掉落。

**1. Overview**

This manual describes specifications, handling and other information on the Mitsubishi general-purpose Programmable Controller renewal tool base adapter ERNT-ASQB38N-S1.  
The Base Adapter ERNT-ASQB38N-S1 is a product which enables a MELSEC-Q Series main base unit Q38B and extension base unit QA1S51B to be installed by utilizing the mounting holes in the MELSEC-AnS Series main base unit A1S38B/A1S38HB. (Additional screw hole machining not required.)

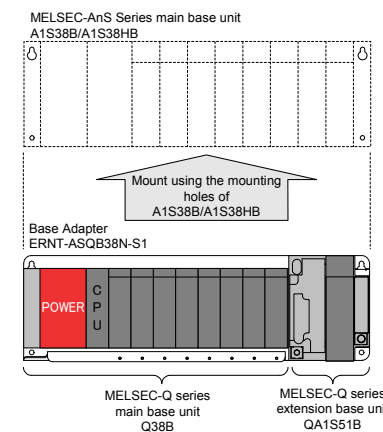

Once you have opened the packaging, verify that it contains the following products.

Product	Quantity
Base Adapter	1
Base Adapter installation screws (M5 X 12)	4
This manual	1

**2. Product Specification**

Base Adapter Model	Specification			Weight (g)
	MELSEC-AnS Series Compatible Module Model	MELSEC-Q Series Compatible Module Model		
		Main	Extension	
ERNT-ASQB38N-S1	A1S38B A1S38HB	Q38B (*1)	QA1S51B	975

\*1 : Q35B and Q33B can be also mounted.

Item	Description
Depth dimension	If a Conversion Adapter is also used to replace a MELSEC-AnS Series unit with a MELSEC-Q Series unit, the depth dimension is "9mm" bigger than the value indicated in the Conversion Adapter's user's manual. Check dimensional data before installation.  (Example) Replacing A1SX10 by QX10 using ERNT-ASQTXY10 Conversion Adapter user's manual (dimension)  110mm 25.5mmUP 135.5mm Conversion Adapter ERNT-ASQTXY10 Base Adapter ERNT-ASQB□□□  Using an ERNT-ASQB38N-S1 base adapter  110mm +9mm 34.5mmUP 144.5mm +9mm Conversion Adapter ERNT-ASQTXY10 Base Adapter ERNT-ASQB38N-S1

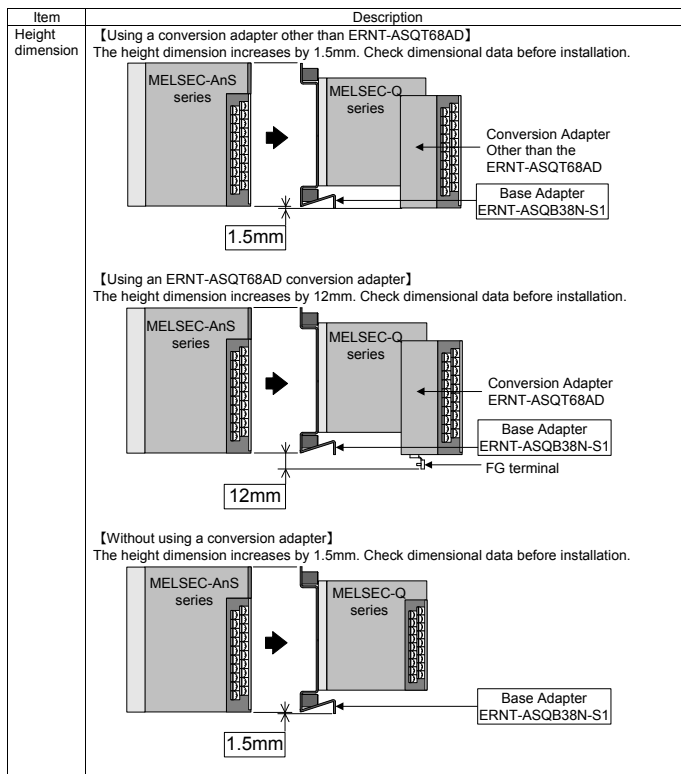

4

#### 4. Installation Dimensions

- The base adapter installation holes (4 locations) have the same installation dimensions as those of the MELSEC-AnS series base unit. There is no need for additional screw hole machining on the control panel.
- The size will be 1.5 mm larger downwardly than the MELSEC-AnS series.
- Adjust the wiring length when replacing the MELSEC-AnS series with the MELSEC-Q series because their module-mounting slot positions are different.

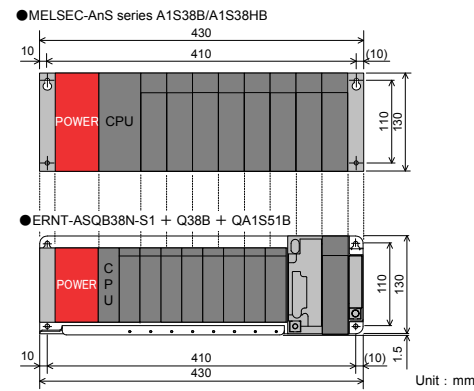

6

#### 6. Part Names and Installation Method

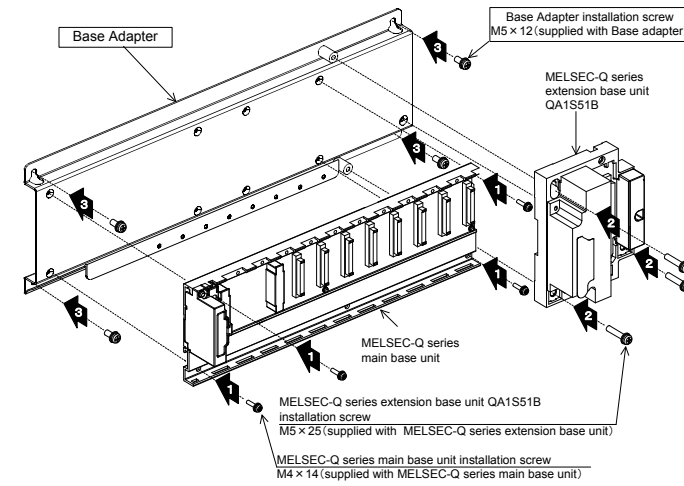

##### 6.1 Installation Method

- Mount the MELSEC-Q series main base unit to the Base Adapter, and secure its position with the installation screws (M4×14) that come with the main base unit. (4 points)
- Mount the MELSEC-Q series extension base unit (QA1S51B) to the Base Adapter, and secure its position with the installation screws (M5×25) that come with the extension base unit. (3 points)
- Mount the Base Adaptor to a panel surface, and secure its position with the Base Adapter installation screws (M5×12) that come with this product. (4 points)

##### 6.2 Tightening Torque

Tighten the installation screws to the specified torque below. An inappropriate tightening torque could cause the product to fall or result in a short circuit, product failure or malfunction.

Screw Location	Tightening Torque Range
MELSEC-Q series main base unit installation screw (M4×14)	1.39 to 1.89 N·m
MELSEC-Q series extension base unit QA1S51B installation screw (M5×25)	1.59 to 2.16 N·m
Base Adapter installation screw (M5×12)	2.75 to 3.63 N·m (*1)

\*1 : When the control panel side (female screw) material is Iron.

8

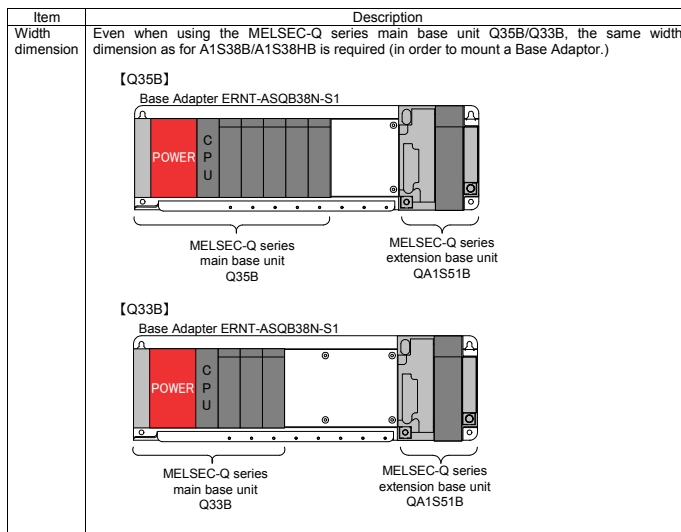

5

#### 5. Installation Location

Install the main base unit (Q33B, Q35B, Q38B) and the extension base unit (QA1S51B) to the locations shown below.

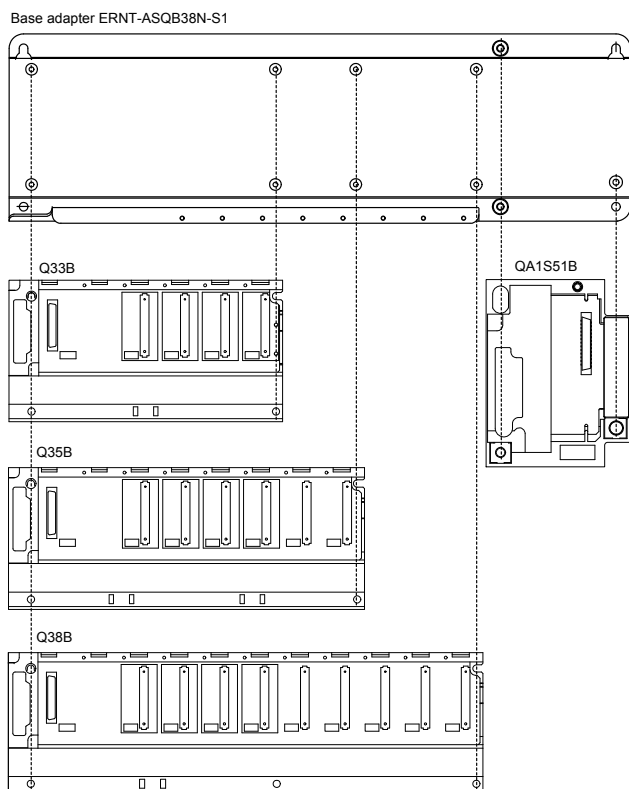

7

#### 7. External Dimensions

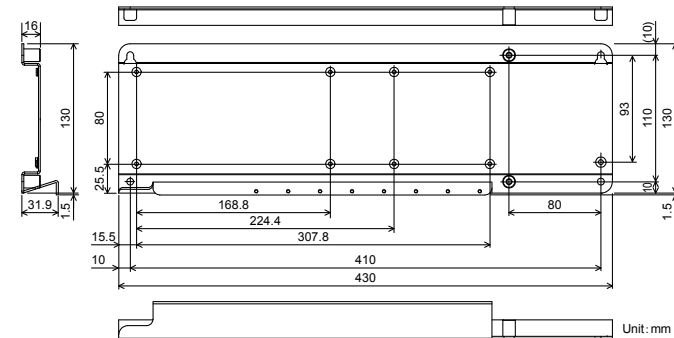

9

#### Product Warranty Details

Please confirm the following product warranty details prior to product use.

#### Gratis Warranty Terms and Gratis Warranty Range

If any fault or defect (hereinafter referred to as "Failure") attributable to Mitsubishi Electric Engineering Company Limited (hereinafter referred to as "MEE") should occur within the gratis warranty period, MEE shall repair the product free of charge via the distributor from whom you made your purchase.

##### ■ Gratis Warranty Period

The gratis warranty period of this product shall be one (1) year from the date of purchase or delivery to the designated place.

Note that after manufacture and shipment from MEE, the maximum distribution period shall be six (6) months, and the gratis warranty period after manufacturing shall be limited to eighteen (18) months.

In addition, the gratis warranty period for repaired products shall not exceed the gratis warranty period established prior to repair.

##### ■ Gratis Warranty Range

The gratis warranty range shall be limited to normal use based on the usage conditions, methods and environment, etc., defined by the terms and precautions, etc., given in the instruction manual, user's manual and caution labels on the product.

#### Warranty Period after Discontinuation of Production

- MEE shall offer product repair services (fee applied) for seven (7) years after production of the product has been discontinued. Discontinuation of production shall be reported via distributors.
- Product supply (including spare parts) is not possible after production has been discontinued.

#### Exclusion of Opportunity Loss and Secondary Loss from Warranty Liability

Regardless of the gratis warranty period, MEE shall not be liable for compensation for damages arising from causes not attributable to MEE, opportunity losses or lost profits incurred by the user due to Failures of MEE products, damages or secondary damages arising from special circumstances, whether foreseen or unforeseen by MEE, compensation for accidents, compensation for damages to products other than MEE products, or compensation for other work carried out by the user.

#### Changes in Product Specifications

The specifications given in the catalogs, manuals and technical documents are subject to change without notice.

This document is a new publication, effective April 2016. Specifications are subject to change without notice.